



New Products



Sensors

Wireless

Lighting & Indicators

Vision

Machine Safety

# More Information Online

For the latest products, brackets, cordsets, accessories, and new solutions, find us on the web at [www.bannerengineering.com](http://www.bannerengineering.com). You also have access to more detailed information such as engineering drawings, complete specifications, installation instructions, product configurators and product videos

The screenshot shows the Banner Engineering website homepage. At the top is a navigation bar with the Banner logo and menu items: INDUSTRIES, PRODUCTS, SOLUTIONS, SUPPORT, and COMPANY. Below the navigation is a large hero section with a background image of a factory floor. The hero section features the headline "SMART SENSORS FOR EVERY CHALLENGE" and a sub-headline: "We provide smart sensor solutions for your most pressing challenges—from clear object detection to remote monitoring and predictive maintenance." A yellow button labeled "Solve More Challenges" is positioned below the sub-headline. Below the hero section are two smaller promotional cards: "Webinar" with a play button icon and "Contact Us" with a person icon. The main content area features a large video player with the same headline "SMART SENSORS FOR EVERY CHALLENGE" and a play button icon. Below the video player is a caption: "SMART SENSORS FOR EVERY CHALLENGE. Solve more applications, save inventory costs, and help prevent unplanned downtime with Banner's smart sensor solutions." Below the video player is a section titled "NEW SOLUTIONS EVERY DAY" featuring a smiling man in a blue sweater. The text below him reads: "WE ARE COMMITTED TO CONSTANT IMPROVEMENT AND CONTINUOUS INNOVATION. Each day, Banner finds new and better ways to solve difficult applications and meet the challenges our customers face today, tomorrow and into the future." Below this section is a yellow "About Us" button. At the bottom of the page is a footer with columns for EXPERTISE (Industries, Products, Solutions), SUPPORT (Our Experts, Video Library, Catalogs, Account Access, Contact Us), NEWS (Expert Insights, Trade Shows, Press Releases, eNewsletter Sign-up), and COMPANY (Company Overview, Careers, Terms of Use, Privacy Policy). There is also a "WHERE TO BUY" section with a search bar and a "CONNECT" section with social media icons for Facebook, Twitter, YouTube, LinkedIn, and Instagram. The Banner logo and company address are at the very bottom: Banner Engineering Corp. | 9714 Tenth Avenue North | Minneapolis, MN 55441 | United States of America.

# Contents

## Sensors

Photoelectric – Opposed	4
Photoelectric – Retroreflective	6
Photoelectric – Miscellaneous	8
Laser Measurement Sensors	10
Ultrasonic Sensors	12
Temperature and Vibration Sensors	13
Fiber Optic Amplifiers	14
Registration Mark, Color, Luminescence	16
Measuring Arrays	16
Slot Sensors	17
Radar Sensors	17
Sensors with IO-Link	18
Featured Products	
T18-2	20
VS8	22
Q5X	24
LM Series	26
RSD	27
Q4X Series	28
LE Series	30
LTF Series	32
QS18 Series	34
QS30 Series	35
Q12 Series	36
Q20 Series	36

## Machine Safety

Safety Light Curtains	40
Emergency Stop	41
Safety Laser Scanners	41
Safety Relays and Controllers	42
Safety Switches	44
Featured Products	
LS Series	46
LS Basic Series	47
LP Series	48
LP Basic Series	49
SLC4 Series	50
SGS Series	51
SX5-B	52
Illuminated	
E-Stop Buttons	53
Self-Checking Touch Buttons (STB)	53
Two-Hand	
Control Runbar	53

## Machine Vision

Vision Sensors and Cameras	56
Vision Lighting	57
Featured Products	
iVu Series	58
VE Series	60

## Barcode Readers

Barcode Readers	66
Featured Products	
ABR Barcode	68
iVu Barcode Reader	70

## Lighting & Indication

LED Task Lighting	76
Tower Lights	78
LED Indicators	80
Touch Buttons	82
Pick-To-Light	83
Featured Product	
PTL110	84

## Connectivity & Monitoring

Wireless Controllers	90
Industrial Wireless Radios	90
Wireless Sensors	91
Wireless Lighting and Indicators	92
Featured Products	
Q120PPB Pendant	93
Q45	94
Photoelectric Sensors	94
Q45	94
Switches and Push Buttons	94
Q45 Nodes	95
Q45	95
All-in-One Sensor	95
Wireless Solutions Kit	96
Tank Level or Vibration	96
DXM Controller	97











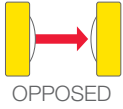

















# Sensors

Banner Engineering has a wide variety of sensors to solve challenging problems all over the world. New and innovative technology in photoelectrics, laser distance measurement, ultrasonics, and fiber optics work to solve almost any industrial automation application.







# Selection Guide | Photoelectric – Opposed



























The sensor's emitter and receiver are housed in two separate units. The emitter is placed opposite the receiver. An object is detected when it breaks the effective beam.

Series	Max Sensing Distance	Power	Dimensions H x W x D (mm)	Special Considerations	Page # or Web
 QS18	20 m	10-30 V dc 20-140 V ac/dc 20-270 V ac/dc	35 x 15 (D varies by model)		34
 QS30	213 m	10-30 V dc 12-250 V ac/dc 24-250 V ac/dc	44 x 22 (D varies by model)		35
 Q12	2 m	10-30 V dc	23 x 8 x 12		36
 Q20	20 m	10-30 V dc	35 x 15 x 31		36
 T18-2	20 m	10-30 V dc 20-250 V ac	DC: 42 x 30 x 30 AC: 52 x 30 x 30		20
 VS8	3 m	10-30 V dc	21.5 x 8 x 14.6		22
 Q45	60 m	10-30 V dc 90-250 V ac 12-250 V ac/dc 5-15 V dc (NAMUR)	88 x 45 x 55		
 MINI-BEAM	30 m	10-30 V dc 24-240 V ac 5-15 V dc (NAMUR)	31 x 12 (D varies by model)		
 Q25	20 m	10-30 V dc 20-250 V ac	50 x 25 x 30		
 Q40	60 m	10-30 V dc 20-250 V ac	70 x 40 x 46		

**KEY**







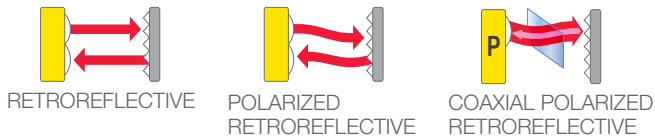



















-  Clear Object
-  Washdown
-  Fast Speed  
≤ 500 μs
-  High Precision
-  Long Range
-  Laser

Series	Max Sensing Distance	Power	Dimensions H x W x D (mm)	Special Considerations	Page # or Web
 TM18	20 m	10-30 V dc	41 x 30 x 30		
 T30	60 m	10-30 V dc 20-250 V ac	52 x 40 x 45		
 M12	5 m	10-30 V dc	ø 12 x 67.5		
 S12 S12-2	20 m 25 m	10-30 V dc	ø 12 x 34		
 S18 S18-2	20 m	10-30 V dc 20-250 V ac	DC: ø 18 x 69 AC: ø 18 x 81		
 M18 M18-3 M18-4	20 m 25 m 25 m	10-30 V dc	ø 18 x 59 ø 18 x 88 ø 18 x 88		
 SM30	150 m	10-30 V dc 24-240 V ac	ø 30 x 99		
 VS2	3 m	10-30 V dc	25 x 12 x 4		
 QM26	8.5 m	10-30 V dc	45 x 14 x 25		





# Selection Guide | Photoelectric – Retroreflective





































The sensor contains both the emitter and receiver elements. The effective beam is established by the size of the retroreflector. As with an opposed-mode sensor, an object is sensed when it interrupts or breaks the effective beam.

Series	Max Sensing Distance	Power	Dimensions H x W x D (mm)	Special Considerations	Page # or Web
 QS18	Retro: 6.5 m Polar Retro: 3.5 m	10-30 V dc 20-140 V ac/dc 20-270 V ac/dc	35 x 15 x 31	  	34
 QS30	Retro: 12 m Polar Retro: 8 m	10-30 V dc 12-250 V ac/dc 24-250 V ac/dc	44 x 22 x 35	  	35
 Q12	Retro: 1.5 m Polar Retro: 1 m	10-30 V dc	23 x 8 x 12		36
 Q20	Retro: 6 m Polar Retro: 4 m	10-30 V dc	35 x 15 x 31		36
 T18-2	Retro: 2 m Polar Retro: 2 m	10-30 V dc 20-250 V ac	DC: 42 x 30 x 30 AC: 52 x 30 x 30		20
 MINI-BEAM	Retro: 5 m Polar Retro: 3 m	10-30 V dc 24-240 V ac 5-15 V dc (NAMUR)	31 x 12 (D varies by model)	 	
 Q25	Polar Retro: 2 m	10-30 V dc 20-250 V ac	50 x 25 x 30		
 Q40	Polar Retro: 6 m	10-30 V dc 20-250 V ac	70 x 40 x 46		
 Q45	Retro: 9 m Polar Retro: 6 m	10-30 V dc 90-250 V ac 24-250 V ac/dc 12-250 V ac/dc 5-15 V dc (NAMUR)	88 x 45 x 55		
 QMT42	Polar Retro: 3 m	10-30 V dc	58 x 18 x 42		

**KEY**

-  Clear Object
-  Washdown
-  Fast Speed  
≤ 500 μs
-  High Precision
-  Long Range







Series	Max Sensing Distance	Power	Dimensions H x W x D (mm)	Special Considerations	Page # or Web
 VS8	Retro: 2 m	10-30 V dc	21.5 x 8 x 14.6		
 TM18	Polar Retro: 5.5 m	10-30 V dc	41 x 30 x 30		
 T30	Polar Retro: 6 m	10-30 V dc 20-250 V ac	52 x 40 x 45		
 M12	Retro: 2.5 m Polar Retro: 1.5 m	10-30 V dc	ø 12 x 67.5	 	
 S18 S18-2	Retro: 2 m Polar Retro: 2 m	10-30 V dc 20-250 V ac	DC: ø 18 x 69 AC: ø 18 x 81		
 M18 M18-3 M18-4	Retro: 2 m Polar Retro: 2 m	10-30 V dc	ø 18 x 59		
 QM26	Polar Retro: 3 m	10-30 V dc	45 x 14 x 25	  	
 Q26	Polar Retro: 800 mm	10-30 V dc	52 x 14 x 25		
 QMH26	Polar Retro: 3 m Coaxial Polar Retro: 2.6 m	10-30 V dc	48.5 x 14 x 25	  	
 VS3	Polar Retro: 250 mm	10-30 V dc	25 x 12 x 4		

# Selection Guide | Photoelectric – Miscellaneous







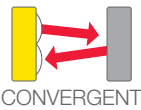





Light from the emitter strikes a surface of an object at some arbitrary angle and is diffused from the surface at all angles. The emitted beam and receiver's field-of-view are very wide.





Series	Max Sensing Distance	Power	Dimensions H x W x D (mm)	Special Considerations	Page # or Web
 MINI-BEAM	130 mm	10-30 V dc 24-240 V ac 5-15 V dc (NAMUR)	31 x 12 (D varies by model)		
 QS18	300 mm	10-30 V dc	35 x 15 x 31		34



Uses additional optics to create a small, intense and well-defined spot at a fixed distance from the front of the sensor lens.

Series	Max Sensing Distance	Power	Dimensions H x W x D (mm)	Special Considerations	Page # or Web
 MINI-BEAM	100 m	10-30 V dc 24-240 V ac 5-15 V dc (NAMUR)	31 x 12 (D varies by model)	 	
 QS18	43 mm	10-30 V dc	35 x 15 x 31	 <b>IO-Link®</b>	34
 Q45	49 mm	10-30 V dc 90-250 V ac 24-250 V ac/dc 12-250 V ac/dc 5-15 V dc (NAMUR)	88 x 45 x 55		
 VS1	15 mm	10-30 V dc	25.7 x 8.3 x 11.6		
 VS2	15 mm	10-30 V dc	25 x 12 x 4.3		

**KEY**

				
Clear Object	Washdown	Fast Speed ≤ 500 μs	High Precision	Long Range

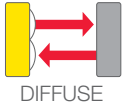















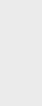













Light from the emitter strikes a surface of an object at some arbitrary angle and is diffused from the surface at all angles.

Series	Max Sensing Distance	Power	Dimensions H x W x D (mm)	Special Considerations	Page # or Web
 Q4X	600 mm	10-30 V dc 20-140 V ac/dc 20-270 V ac/dc	35 x 15 (D varies by model)		28
 Q3X	300 mm	10-30 V dc	35 x 18 x 35		
 QS18	800 mm	10-30 V dc 20-140 V ac/dc 20-270 V ac/dc	35 x 15 (D varies by model)		34
 QS30	1.4 m	10-30 V dc 12-250 V ac/dc 24-250 V ac/dc	44 x 22 (D varies by model)		35
 Q20	1.5 m	10-30 V dc	35 x 15 x 31		
 T18-2	500 mm	10-30 V dc	42 x 30 x 30		20
 Q45	3 m	10-30 V dc 90-250 V ac 12-250 V ac/dc 5-15 V dc (NAMUR)	88 x 45 x 55		
 MNI-BEAM	380 mm	10-30 V dc 24-240 V ac 5-15 V dc (NAMUR)	31 x 12 (D varies by model)		
 TM18	500 mm	10-30 V dc	41 x 30 x 30		
 S18 S18-2	300 mm	10-30 V dc or 20-250 V ac	DC: ø 18 x 69 AC: ø 18 x 81		
 M18 M18-3 M18-4	300 mm	10-30 V dc	ø 18 x 59		
 M12	400 mm	10-30 V dc	ø 12 x 67.5		

# Selection Guide | Laser Measurement Sensors



Laser measurement sensors from Banner Engineering solve a wide variety of discrete sensing applications. A discrete sensor's output is either on or off.

Series	Sensing Range	Repeatability (mm)	Minimum Object Separation (mm)	Dimensions H x W x D (mm)	Special Considerations	Page # or Web
 LM	50 to 150 mm	±0.002	0.12 to 0.14	48.5 x 23.5 x 35.8	    	26
 Q4X100 Q4X300 Q4X500 Q4X600	25 to 100 mm 25 to 300 mm 25 to 500 mm 25 to 600 mm	±0.2 ±0.5 to 3.0 ±0.5 to 5.0 ±0.5 to 3.0	0.5 to 1.0 1.0 to 13.5 1.0 to 30.0 1.0 to 10.0	57.4 x 18 x 43.6	  	28
 Q4XF	35 to 110 mm 35 to 310 mm 35 to 610 mm	±0.2 ±0.5 to 3.0 ±0.5 to 3.0	0.5 to 1.0 1.0 to 13.5 1.0 to 10.0	57.4 x 18 x 32.5	  	28
 LE250 LE550	100 to 400 mm 100 to 1 m	±0.01 to 0.1 ±0.125 to 0.5	0.5 to 1.0 2.0 to 8.0	60 x 26 x 56	 	30
 LTF12 LTF24	50 mm to 12 m 50 mm to 24 m	±0.45 to 4.5 ±0.45 to 6.0	1.8 to 18.0 1.8 to 24.0	77 x 26 x 56	 	32
 Q5X	9.5 cm to 2 m	±0.5 to 10.0	±1.0 to 35.0	60 x 25 x 52	 	24
 LT3	Retro: 500 mm to 50 m	±5.0 to 6.0		68.5 x 35.3 x 87		
 LT7	Retro: 500 mm to 250 m	±2.0		93 x 42 x 95		





## Repeatability

How reliably a sensor can repeat the same measurement in the same conditions. Repeatability of 0.5 mm means that multiple measurements of the same target will be within ± 0.5 mm.

## Minimum Object Separation (MOS)













The minimum distance a target must be from the background to be reliably detected by a sensor. A MOS of 0.5 mm means the sensor can reliably detect an object that is at least 0.5 mm from the background.

**KEY**

				
Clear Object	Washdown	Fast Speed ≤ 500 μs	High Precision	Long Range



Laser measurement sensors from Banner Engineering solve a wide variety of analog applications. Analog sensors display the output value as either a function of voltage or current.

Series	Sensing Range	Resolution (mm)	Linearity (mm)	Dimensions H x W x D (mm)	Special Considerations	Page # or Web
 LM	50 to 150 mm	0.004	$\pm 0.060$ to $\pm 0.070$	48.5 x 23.5 x 35.8		26
 LH30 LH80 LH150	50 to 35 mm 50 to 100 mm 50 to 200 mm	0.001 0.004 0.01	$\pm 0.01$ $\pm 0.04$ $\pm 0.1$	80 x 32 x 65		
 Q4X100 Q4X300 Q4X500	25 to 100 mm 25 to 300 mm 25 to 500 mm	0.15 0.3 to 1.0 0.3 to 1.75	$\pm 0.25$ to 1.0 $\pm 0.8$ to 9.0 $\pm 0.8$ to 25.0	57.4 x 18 x 43.6		28
 Q4XF	35 to 110 mm 35 to 310 mm	0.15 0.3 to 1.0	$\pm 0.25$ to 1.0 $\pm 0.8$ to 9.0	57.4 x 18 x 32.5		28
 LE250 LE550	100 to 400 mm 100 mm to 1 m	0.02 to 0.2 0.5 to 1.0	$\pm 0.375$ to 0.9 $\pm 2.0$ to 4.5	60 x 26 x 56		30
 LTF12 LTF24	50 mm to 12 m 50 mm to 24 m	0.9 to 9.0 0.9 to 12.0	$\pm 10.0$ $\pm 25.0$	77 x 26 x 56		32

#### Resolution

The smallest change in distance a sensor can detect. A resolution of 0.5 mm means that the sensor can detect changes in distance of 0.5 mm.

#### Linearity





How closely a sensor's analog output approximates a straight line across the measuring range. The more linear the sensor's measurements, the more consistent the measurements across the full range of the sensor. Linearity of 0.5 mm means that the greatest variation in measurement across the sensor's range is  $\pm 0.5$  mm.

# Selection Guide | Ultrasonic Sensors

Ultrasonic sensors use sound waves rather than light, making them ideal for stable detection of uneven surfaces, liquids, clear objects, and objects in dirty environments. These sensors work well for applications that require precise measurements between stationary and moving objects.







Series	Sensing Range	Analog Resolution or Discrete Repeatability	Output Configuration	Dimensions H x W x D (mm)	Special Considerations	Page # or Web
 QT50U	200 mm to 8 m	1.0 mm	SPDT Electromagnetic Relay Dual Discrete Both NPN or Both PNP Analog 0 to 10 V dc or 4 to 20 mA	84.2 x 74.1 x 67.4		
 S18U	30 to 300 mm	Discrete: 0.5 mm Analog: Fast 2.5 mm Slow 0.5 mm	Discrete Bipolar NPN/PNP Analog/Discrete NPN or PNP 0 to 10 V dc or 4 to 20 mA	ø 18 x 80.8		
 T30UX	100 mm to 1 m 200 mm to 2 m 300 mm to 3 m	0.1% of sensing distance A models: 0.5 mm minimum B models: 1.0 mm minimum C models: 1.5 mm minimum	Discrete NPN or PNP NO or NC Analog 0 to 10 V dc or 4 to 20 mA	51.5 x 40 x 45		
 T30U	150 mm to 1 m 300 mm to 2 m	0.25% of sensing distance	Dual Discrete Both NPN or Both PNP Analog 0 to 10 V dc or 4 to 20 mA	51.5 x 40 x 45		
 M25U	250 or 500 mm		Discrete Bipolar NPN/PNP	ø 25 x 103		
 T18U	300 or 600 mm		Complimentary NPN or PNP (1 NO, 1 NC)	51.5 x 40 x 30		
 Q45U	100 mm to 1.4 m 250 mm to 3 m	Short: 0.1% of sensing distance (0.25 mm minimum) Long: 0.1% of sensing distance (0.5 mm minimum)	Discrete Bipolar NPN/PNP Analog 0 to 10 V dc or 4 to 20 mA	87.6 x 44.5 x 60.5		
 Q45UR	50 mm to 250 mm	0.2% of sensing distance	Discrete Bipolar NPN/PNP Analog 0 to 10 V dc or 4 to 20 mA	87.6 x 44.5 x 60.5		
 QS18U	50 to 500 mm	0.7 mm	Discrete NPN or PNP	41.5 x 15 x 33.5		
 K50U	100 mm to 1 m 300 mm to 3 m	0.1 % of sensing distance (1.5 mm minimum)	Discrete RS-285 1-wire serial	ø 50 x 59.5	• Compatible with Banner Wireless	

**KEY**

				
Pump In Pump Out	Temp Comp	Chemical Resistant	Vibration	Washdown

# Temperature and Vibration Sensors

Temperature sensors detect the temperature of an object or an environment in a variety of ways. The vibration and temperature sensor measures RMS velocity, in inches per second or millimeters per second, and temperature.

Series	Sensing Ability	Power	Dimensions H x W x D (mm)	Special Considerations	Page # or Web
 M18T	Senses temperature differences as small as 3 °C	12 to 30 V dc	ø 18 (D varies by model)	 • Non-contact surface temperature	
 M12FTH M12FT	Humidity: 0.1% Temperature: 0.1 °C	12 to 24 V dc 3.6 to 5.5 V dc	ø 12 (D varies by model)	 • Environment temperature • Compatible with Banner Wireless	
 QM42VT	Accuracy ± 10% @ 25 °C	3.6 to 5.5 V dc	42 x 13 x 42	 • Vibration • Contact surface temperature • Compatible with Banner Wireless	



# Selection Guide | Fiber Optic Amplifiers

Simple user interface. Highly visible dual display. Easy sensor set up.

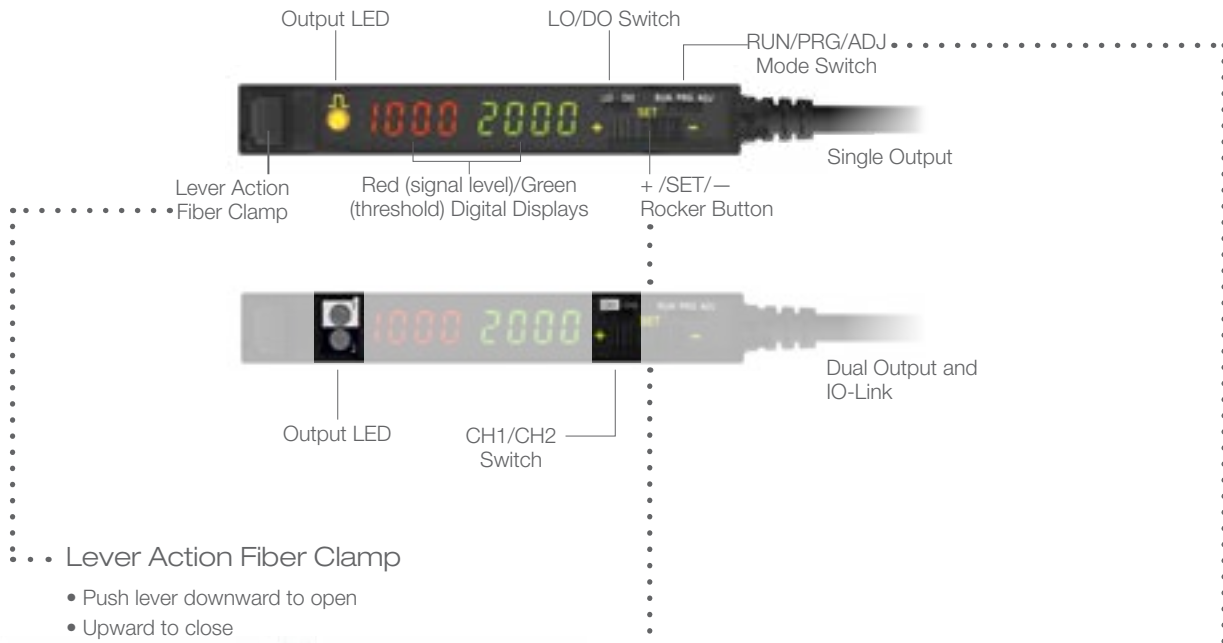

### Lever Action Fiber Clamp

- Push lever downward to open
- Upward to close

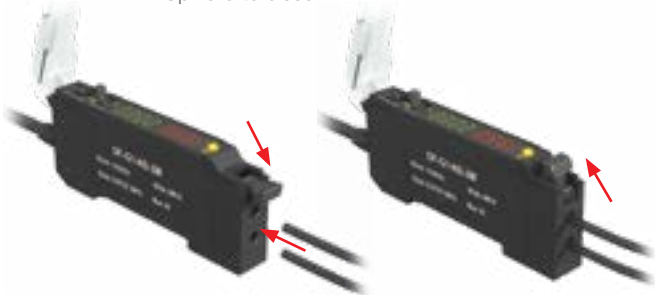

### User Interface

- Light Operate and Dark Operate Slide Switch is easy to see and change the selection
- Run, Program and Adjust Mode Switch
  - RUN locks out changes
  - PROGRAM (PRG) allows for full sensor configuration
  - ADJUST (ADJ) enables threshold adjust and teaching

















### Rocker Button

- Three position Jog Switch
  - Rocker Switch (+) and (-) precisely adjusts thresholds and easily navigate menus
  - Press to initiate Teach and SETs, and allow selection of displayed menu



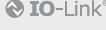

+ /SET/-  
Rocker Button





Series	Output Response Time	Power	Dimensions H x W x D (mm)	Special Considerations	Page # or Web
 DF-G3	500 $\mu$ s (varies by model)	NPN/PNP models: 10 to 30 V dc IO-Link models: 18 to 30 V dc	33.0 x 72.0 x 10.0	Discrete and Analog   	
 DF-G2	10 $\mu$ s (varies by model)	NPN/PNP models: 10 to 30 V dc IO-Link models: 18 to 30 V dc	33.0 x 72.0 x 10.0	Discrete     	
 DF-G1	High Speed: 200 $\mu$ s Long Range: 2 ms Extra Long Range: 5 ms	NPN/PNP models: 10 to 30 V dc IO-Link models: 18 to 30 V dc	33.0 x 72.0 x 10.0	Discrete   	

**KEY**

			
High Power	Water Detection	Fast Response	Light Intensity

## What Are Fiber Optics?

Fiber optics are used to transmit light over long distances. Optical fibers are thin, transparent strands of optical quality glass or plastic that can be as thin as a strand of hair. In photoelectric sensing, these fibers are used to transmit and/or receive light from the LED of a sensor.

### Plastic Fiber Optic Assemblies

Plastic fiber optics usually have a large, monofilament core which comes in a single strand of fiber optic. Advances in LED technology have improved the performance and range of plastic fiber optic sensing systems to the point that they are nearly equivalent to glass fibers. Plastic fibers are a versatile, cost-effective choice for many fiber optic sensing applications.



#### Advantages:

- Less expensive
- Allow less signal attenuation
- More flexible
- Survive well under repeated flexing
- Can be cut to length in the field
- Can be routed into extremely tight areas

### Glass Fiber Optic Assemblies

Most glass fiber optic assemblies are very rugged and perform reliably in extreme temperatures, corrosive environments, or even in a vacuum. Glass fiber optic assemblies can transmit both visible and infrared light, where plastic fiber optics can only transmit visible light. A common problem experienced with glass fibers is breakage of the individual strands resulting from sharp bending or continued flexing, as occurs on reciprocating mechanisms. Banner glass fibers with a T5 connection identifier in their model numbers are compatible with DF-G plastic amplifiers.













#### Advantages:

- Powerful and very rugged
- Can carry infrared light to provide longer range
- Reliable in extreme temperatures and harsh environments

A full line of glass fibers and compatible amplifiers are available on [www.bannerengineering.com](http://www.bannerengineering.com)









# Selection Guide | Measuring & Detection Arrays

Using an array of closely spaced light beams, measuring light screens are designed for profiling, inspections and process monitoring.

Series	Beam Spacing (mm)	Max. Range (m)	Array Lengths (mm)	Outputs	Special Considerations	Page # or Web
 EZ-ARRAY	5	4	150 to 2400	IO-Link v 1.0 2 Analog, 2 Discrete, RS-485		
 2-Stick MINI-ARRAY	9.5 19.1	6.1 17	133 to 1819	2 Discrete, RS-485		
 MINI-ARRAY	9.5 19.1	6.1 17	133 to 1819	16 Discrete, RS-232 2 Analog, 1 Discrete, RS-232 2 Discrete, RS-485, RS-232 1 Reed Relay, 1 Discrete, RS-485, RS-232		
 High Res MINI-ARRAY	2.5	1.8	163 to 1951	2 Discrete, 2 Analog, RS-232/ RS-485		
 LX	9.5 (crosshatch)	2	67 to 599	Bipolar NPN/PNP	Part Detection Array Minimum Object Size: down to 5.6 mm	







## Registration Mark, Color, Luminescence

Registration mark sensors, also known as color contrast sensors, act as a color detector by identifying subtle color contrasts to inspect registration marks, using one, two, or three color LEDs.

Series	Max Sensing Range	Power	Dimensions H x W x D (mm)	Special Considerations	Page # or Web
 Q26	30 mm	12 to 30 V dc	14 x25 x 42	Compact luminescence sensor	
 R58	10 mm	10 to 30 V dc	62.1 x 30 x 83.3	Registration mark sensor	
 Q3X	300 mm	10 to 30 V dc	50 x 25 x 50	Long-range red laser contrast sensor	
 QCM50	150 mm	15 to 30 V dc	50 x 25 x 50	Color sensor Glare suppression 	







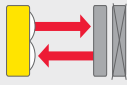

# Slot Sensors

Slot sensors, sometimes called optical fork sensors because of their “forked” shape, detect objects that pass between the two arms—one with the emitter, the other with the receiver. The fixed slot width provides reliable opposed-mode sensing of objects as small as 0.30 mm.

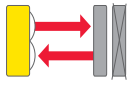
Series	Max Sensing Distance	Response Time	Slot Opening (mm)	Dimensions H x W x D (mm)	Special Considerations	Page # or Web
 SLM	220 mm	500 $\mu$ s	10-200 depending on model	Max size: 12 x 252 x 140	Metal Slot Sensor	
 SL10	10 mm	1 ms or 300 $\mu$ s depending on model	10	72 x 52 x 19	10 mm Fixed Slot Sensor	
 SL30	30 mm	1 ms or 300 $\mu$ s depending on model	30	72 x 52 x 19	30 mm Fixed Slot Sensor	

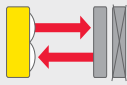
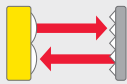
# Radar Sensors

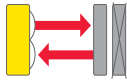
Radar sensors use Frequency Modulated Continuous Wave (FMCW) radar to reliably detect moving or stationary targets, including cars, trains, trucks, and cargo in extreme weather conditions. Radar-based sensors are ideal for collision avoidance on board mobile equipment such as reach stackers, forklifts, and mining vehicles or port machineries such as carriers, handlers, and shippers.

Series	Sensing Mode	Max Sensing Distance	Beam Angle	Dimensions H x W x D (mm)	Output	Configuration	Page # or Web
 Q120R		40 m	24° x 50°	159.5 x 90.8 x 62	Single or Dual Discrete	DIP-switch selectable	
 Q240R		100 m	11° x 13°	186.9 x 159.9 x 55.5	Analog and Discrete or Dual Discrete	DIP-switch selectable	
 QT50R	 	24 m	90° x 76°	100.2 x 74.1 x 46.1	Single or Dual Discrete	DIP-switch selectable	
 Q130R		40 m	90° x 76° or 24° x 50°	130 x 90 x 29	Single Discrete	PC GUI	

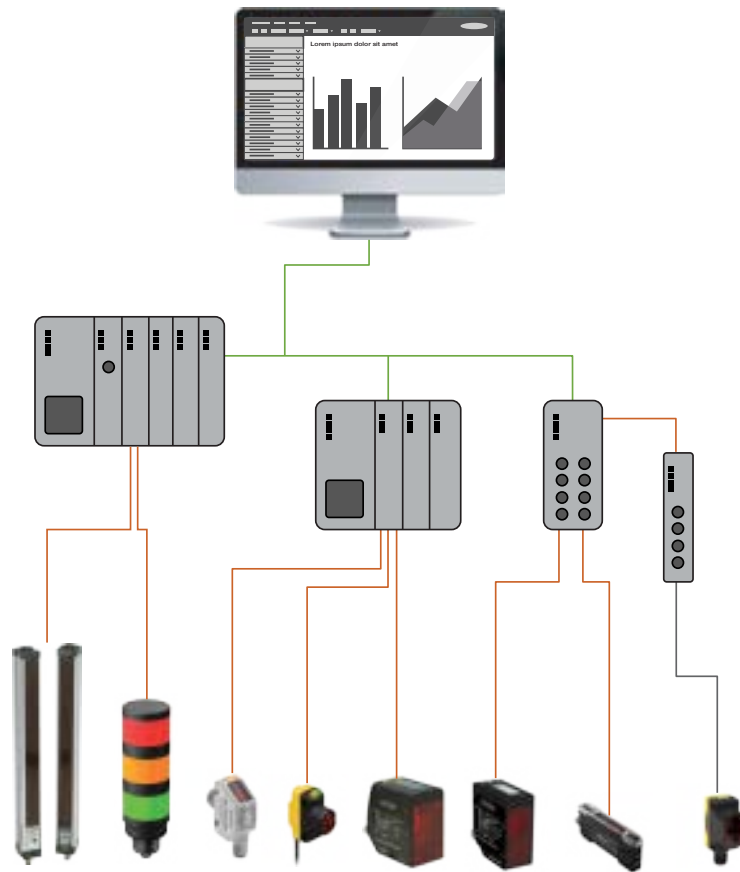

## 5 Advantages of IO-Link

### 1. Standardized and Reduced Wiring

IO-Link devices do not require any special or complicated wiring, but can be connected using the same cost-effective standard unshielded 3-wire cables as conventional discrete I/O. In addition, IO-Link eliminates the need for analog sensors and reduces the variety of cordsets required for sensors, which saves inventory costs. IO-Link also supports a master-slave configuration with passive connection points, which further reduces wiring requirements.

### 2. Increased Data Availability

Access to sensor-level data helps ensure the smooth operation of system components, streamlines device replacement, and enables optimized machine maintenance schedules—all of which save costs and reduce the risk of machine downtime.

This wealth of valuable data made available through IO-Link is integral for the Industrial Internet of Things (IIoT) and Industry 4.0 initiatives.

### 3. Remote Configuration and Monitoring

With IO-Link, users can read and change device parameters through the control system software, enabling fast configuration and commissioning that saves time and resources. IO-Link allows operators to dynamically change the sensor parameters from the control system as needed—such as in the case of product changeover—which reduces downtime and allows machines to accommodate greater product diversity.

The ability to monitor sensor outputs, receive real-time status alerts, and adjust settings from virtually anywhere allows users to identify and resolve problems that arise on the sensor level in a timely manner. This capability reduces costly downtime and improves overall efficiencies.

### 4. Simple Device Replacement

In addition to the ability to remotely adjust sensor settings, IO-Link's data storage capability also allows for automated parameter reassignment in case of device replacement (also known as Auto-Device Replacement or ADR). The system automatically imports existing sensor parameter values into a replacement sensor for seamless replacement, getting the new device up and running as quickly as possible.



















### 5. Extended Diagnostics

IO-Link provides users with visibility into errors and health status from each device. This means that users can see not only what the sensor is doing but also how well it is performing—a valuable insight into a machine's efficiency. Extended diagnostics allow users to easily identify when a sensor is malfunctioning and diagnose the problem without shutting down the line or machine.

The combination of real-time and historic data not only reduces troubleshooting efforts as issues arise but also allows for optimization of machine maintenance schedules, saving costs and increasing efficiency in the long term.



IO-Link (IEC61131-9) is an open standard serial communication protocol that allows for the bi-directional exchange of data from sensors and devices that support IO-Link and are connected to a master. The IO-Link master can transmit this data over various networks, fieldbuses, or backplane buses, making the data accessible for immediate action or long-term analysis via an industrial information system (PLC, HMI, etc.). Each IO-Link sensor has an IODD (IO Device Description) file that describes the device and its IO-Link capabilities.

Series	Sensing Range	Repeatability (mm)	Accuracy (mm)	Dimensions H x W x D (mm)	Special Considerations	Page # or Web
 LM	50 to 150 mm	±0.002	±0.2	48.5 x 23.5 x 35.8	  <b>MPD</b>	26
 Q4X100 Q4X300 Q4X600	25 to 100 mm 25 to 300 mm 25 to 600 mm	±0.2 ±0.5 to 3.0 ±0.5 to 3.0	±0.25 to 1.0 ±0.8 to 9.0 ±0.8 to 25.0	57.4 x 18 x 43.6	  	28
 Q4XF110 Q4XF310 Q4XF610	35 to 110 mm 35 to 310 mm 35 to 610 mm	±0.2 ±0.5 to 3.0 ±0.5 to 3.0	±0.25 to 1.0 ±0.8 to 9.0 ±0.8 to 25.0	57.4 x 18 x 43.6	  	28
 LE250 LE550	100 to 400 mm 100 mm to 1 m	±0.01 to 0.1 ±0.125 to 6.0	±0.375 to 1.0 ±2.0 to 10.0	60 x 26 x 56		30
 Q5X	9.5 to 2 mm	±0.5 to 10.0	±3.0 to 35.0	60 x 25 x 52	  <b>MPD</b>	24
 LTF12 LTF24	50 mm to 12 m 50 mm to 24 m	±0.45 to 4.5 ±0.45 to 6.0	±10.0 ±25.0	77 x 26 x 56		32
 QS18	Diffuse: 900 mm Polar Retro: 3.5 m Convergent: 43 mm Clear Object: 3 m			35 x 15 x 31 (varies by model)	 <b>MPD</b>	34
 Q20	30 to 200 mm			35 x 15 x 31		36
 QCM50	Anti-Glare: 18 to 32 mm Small Spot: 18 to 60 mm Long Range: 20 to 150 mm			50 x 25 x 50	 	

**KEY**

			<b>MPD</b> Modular Process Data		
Percent Match	Internal Temp Monitoring	Laser Disable		Washdown	Clear Object



## T18-2

### Washdown Sensors for Harsh Environments

- IP69K epoxy encapsulated for maximum reliability in wet thermal shock environments
- ECOLAB™ certified FDA grade plastic housing
- Ultrasonically welded joints for superior sealing and durability
- Improved hygienic design for easier cleaning
- Available with integral M12 quick disconnect and 2 or 9 meter cable

#### Emitter/Receiver

Type	Range	Output	Model*
Emitter	25 m (82 ft)	None	<b>T18-2NAEL-Q8</b>
	25 m (82 ft) with beam inhibit		<b>T18-2NAEJ-Q8</b>
	25 m (82 ft) with LED adjustment potentiometer		<b>T18-2NAES-Q8</b>
Receiver	25 m (82 ft)	Complementary NPN	<b>T18-2VNRL-Q8</b>
		Complementary PNP	<b>T18-2VPRL-Q8</b>
	25 m (82 ft) with gain adjustment potentiometer	Complementary NPN	<b>T18-2VNRS-Q8</b>
		Complementary PNP	<b>T18-2VPRS-Q8</b>

#### Polarized Retroreflective

Range	Output	Model*
6 m (19.7 ft) with BRT-84 reflector	Complementary NPN	<b>T18-2VNLP-Q8</b>
	Complementary PNP	<b>T18-2VPLP-Q8</b>
6 m (19.7 ft) with BRT-84 reflector, with gain adjustment potentiometer	Complementary NPN	<b>T18-2VNLPC-Q8</b>
	Complementary PNP	<b>T18-2VPLPC-Q8</b>

\* Integral 4-pin M12/Euro-style quick disconnect models are listed.

- To order the 2 m (6 ft) cable model, replace the suffix "-Q8" with "-2M"
- To order the 9 m (30 ft) cable model, replace the suffix "-Q8" with "-9M"

## Next Generation of Washdown Sensors



### Diffuse

Range	Output	Model*
750 mm (29.5 in) with adjustment	Complementary NPN	<b>T18-2VNDL-Q8</b>
	Complementary PNP	<b>T18-2VPDL-Q8</b>
300 mm (11.8 in) with gain adjustment potentiometer	Complementary NPN	<b>T18-2VNDS-Q8</b>
	Complementary PNP	<b>T18-2VPDS-Q8</b>

### Fixed Field

Range	Output	Visible Red Emitter Models*	Infrared Emitter Models*
30 mm	Complementary NPN	<b>T18-2VNFF30-Q8</b>	<b>T18-2VNFF30IR-Q8</b>
	Complementary PNP	<b>T18-2VPFF30-Q8</b>	<b>T18-2VPFF30IR-Q8</b>
50 mm	Complementary NPN	<b>T18-2VNFF50-Q8</b>	<b>T18-2VNFF50IR-Q8</b>
	Complementary PNP	<b>T18-2VPFF50-Q8</b>	<b>T18-2VPFF50IR-Q8</b>
75 mm	Complementary NPN	<b>T18-2VNFF75-Q8</b>	<b>T18-2VNFF75IR-Q8</b>
	Complementary PNP	<b>T18-2VPFF75-Q8</b>	<b>T18-2VPFF75IR-Q8</b>
100 mm	Complementary NPN	<b>T18-2VNFF100-Q8</b>	<b>T18-2VNFF100IR-Q8</b>
	Complementary PNP	<b>T18-2VPFF100-Q8</b>	<b>T18-2VPFF100IR-Q8</b>
150 mm	Complementary NPN	<b>T18-2VNFF150-Q8</b>	<b>T18-2VNFF150IR-Q8</b>
	Complementary PNP	<b>T18-2VPFF150-Q8</b>	<b>T18-2VPFF150IR-Q8</b>
200 mm	Complementary NPN	<b>T18-2VNFF200-Q8</b>	<b>T18-2VNFF200IR-Q8</b>
	Complementary PNP	<b>T18-2VPFF200-Q8</b>	<b>T18-2VPFF200IR-Q8</b>

\* Integral 4-pin M12/Euro-style quick disconnect models are listed.

- To order the 2 m (6 ft) cable model, replace the suffix "-Q8" with "-2M"
- To order the 9 m (30 ft) cable model, replace the suffix "-Q8" with "-9M"



## VS8 Miniature Sensors

- Installs in the smallest of spaces
- Red laser models provide bright, precise laser light spot for optimum small part detection
- High switching frequency for detection in even the fastest processes
- User-friendly operation using electronic push button or remote input provides reliable and precise detection
- Red laser, Red LED, and Blue LED versions to solve challenging applications
- ECOLAB and IP67

### Opposed Mode

Sensing Mode	Range	Output	Connection	Model
Red Laser Emitter with Beam Inhibit	0 to 3 m (0 in to 9.8 ft)	—	2 m (6.5 ft) unterminated 4-wire PUR cable	VS8LEJ
Red Laser Emitter with Beam Inhibit	0 to 3 m (0 in to 9.8 ft)	—	200 mm (7.8 in) PUR cable with a 4-pin M8/Pico-style male quick disconnect (QD)	VS8LEJQ
Receiver	0 to 3 m (0 in to 9.8 ft)	PNP NPN	2 m (6.5 ft) unterminated 4-wire PUR cable	VS8EAPR VS8EANR
Receiver	0 to 3 m (0 in to 9.8 ft)	PNP NPN	200 mm (7.8 in) PUR cable with a 4-pin M8/Pico-style male quick disconnect (QD)	VS8EAPRQ VS8EANRQ

### Retroreflective Mode

Sensing Mode	Range	Output	Connection	Model
Red LED Retro Reflective	0.1 m to 1.6 m (3.9 in to 62.9 in) with BRT-2X2	PNP NPN	2 m (6.5 ft) unterminated 4-wire PUR cable	VS8EAPLP VS8EANLP
Red LED Retro Reflective	0.1 m to 1.6 m (3.9 in to 62.9 in) with BRT-2X2	PNP NPN	200 mm (7.8 in) PUR cable with a 4-pin M8/Pico-style male quick disconnect (QD)	VS8EAPLPQ VS8EANLPQ
Red Laser Retro Reflective	0.1 m to 2 m (3.9 in to 78.7 in) with BRT-51X51BM	PNP NPN	2 m (6.5 ft) unterminated 4-wire PUR cable	VS8EAPLLP VS8EANLLP
Red Laser Retro Reflective	0.1 m to 2 m (3.9 in to 78.7 in) with BRT-51X51BM	PNP NPN	200 mm (7.8 in) PUR cable with a 4-pin M8/Pico-style male quick disconnect (QD)	VS8EAPLLPQ VS8EANLLPQ



## Miniature Size



## Industry Standard Mounting

- 15 mm spacing on mounting holes
- Dovetail mounting option allows  $\pm 10^\circ$  tip/pivot adjustments of the sensor even when installed in tight spaces

## Ultra Small Beam Spot

- Can reliably detect an object with a diameter of 0.5 mm at a distance of 70 mm (laser adjustable-field and fixed background suppression models)

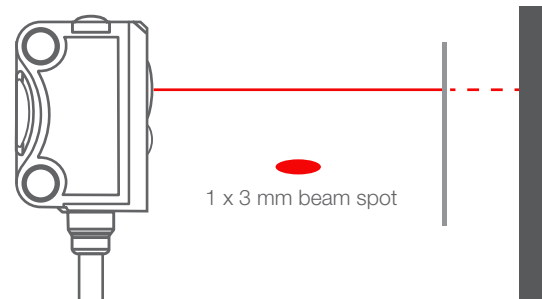

## Background Suppression

Sensing Mode	Range	Output	Connection	Model
Red LED, Adjustable Background Suppression	5 to 70 mm (0.20 to 2.75 in)	PNP NPN	2 m (6.5 ft) unterminated 4-wire PUR cable	VS8EAPAF70* VS8EANAF70*
Red Laser, Adjustable Background Suppression	6 to 70 mm (0.24 to 2.75 in)	PNP NPN	2 m (6.5 ft) unterminated 4-wire PUR cable	VS8EAPLAF70* VS8EANLAF70*
Blue LED, Fixed 30 mm Background Suppression	2 to 30 mm (0.08 to 1.18 in)	PNP NPN	2 m (6.5 ft) unterminated 4-wire PUR cable	VS8APFF30B** VS8ANFF30B**
Red LED, Fixed 15 mm Background Suppression	2 to 15 mm (0.08 to 0.59 in)	PNP NPN	2 m (6.5 ft) unterminated 4-wire PUR cable	VS8APFF15** VS8ANFF15**
Red LED, Fixed 30 mm Background Suppression	2 mm to 30 mm (0.08 to 1.18 in)	PNP NPN	2 m (6.5 ft) unterminated 4-wire PUR cable	VS8APFF30** VS8ANFF30**
Red LED, Fixed 50 mm Background Suppression	2 mm to 50 mm (0.08 to 1.97 in)	PNP NPN	2 m (6.5 ft) unterminated 4-wire PUR cable	VS8APFF50** VS8ANFF50**

\* To order the 200 mm (7.8 in) PUR cable model with a 4-pin M8/Pico-style quick disconnect, add suffix "Q" to the model number. For example, VS8EAPAF70Q. Only available for AF and LAF models.

To order the 200 mm (7.8 in) PUR cable model with a 4-pin M12/Euro-style quick disconnect, add suffix "Q5" to the model number. For example, VS8EAPAF70Q5. Only available for AF and LAF models.

\*\* To order the 200 mm (7.8 in) PUR cable model with a 3-pin M8/Pico-style quick disconnect, add suffix "Q3" to the model number. For example, VS8APFF15Q3. Only available for FF models.



## Q5X High Power, Mid-Range Laser Measurement Sensor

- Reliable detection from 9.5 cm to 2 m, even at an angle
- Compact housing and rotatable QD for tight spaces
- Reduce inventory and verify multiple conditions with a single device
- Simplified setup, remote monitoring, control and replacement with optional Remote Sensor Display(RSD)

### Minimum Object Separation (MOS)

The minimum distance a target must be from the background to be reliably detected by a sensor. A MOS of 5 mm means the sensor can detect an object that is at least 5 mm from the background.

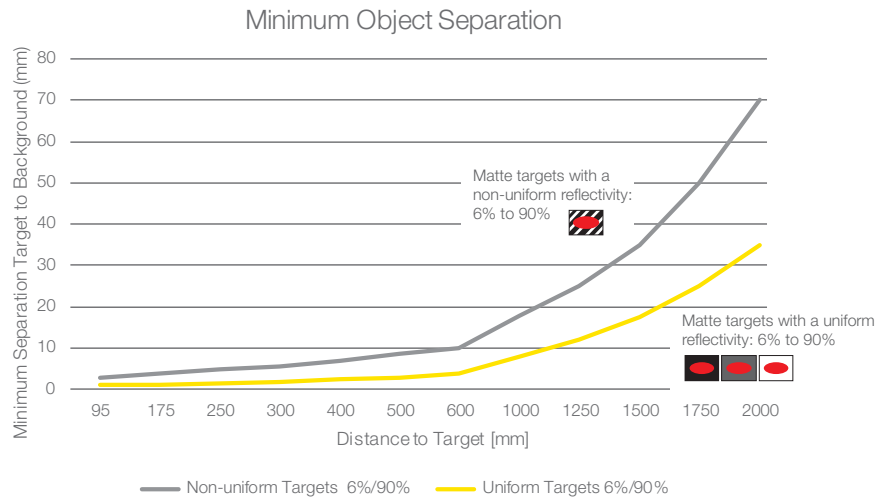
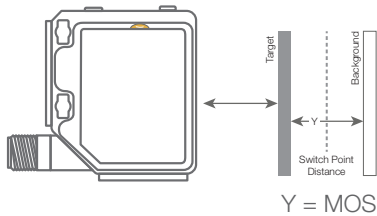

Series	Output	Emitter	Mode	Range (mm)	Connector
<b>Q5X</b>	<b>K</b>	<b>L</b>	<b>AF</b>	<b>2000</b>	<b>Q8</b>
K = Configurable Dual Discrete with IO-Link on all models		L = Laser	AF = Adjustable Field Background Suppression	2000 = 2000 (max. specified & settable switch point detection range)	Q8 = Integral Swivel M12 connector

- 4-digit display and 3 button interface for easy set-up and adjustment
- Distance to target viewable as centimeters (default) or inches



**IO-Link®**

Program with push button, remote teach, IO-Link, or optional Remote Sensor Display (RSD1QP). Cordset MQDC-4501SS required to use RSD.



Rated IP67 for reliable performance in wet environments



Protective bracket for use in harsh environments



Class 2 laser with small, highly visible spot for easy alignment and small object detection



270-degree rotatable M12 QD for simple mounting

## Reliably Detects Challenging Targets



Round



Uneven



Shiny or metal



Dark surface



Multicolored



Clear

Dynamically adjusted laser power increases output for dark targets or objects at steep or uneven angles, while reducing power for shiny targets, providing accurate measurements across a wide range of challenging targets. A small beam spot minimizes measurement variation across color transitions.

## LM Series

### Compact Precision Laser Measurement Sensor



- Superior precision for real world applications
- Best in class thermal & mechanical stability
- Small housing design for the tightest spaces
- High response speed for fast moving targets
- Simplified set up, control and replacement with optional Remote Sensor Display(RSD)

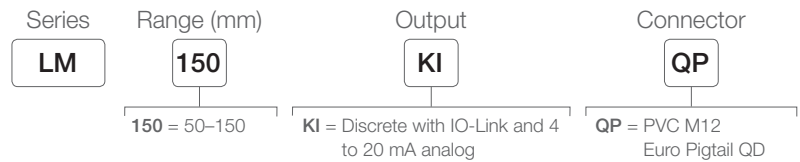

### Linearity

Linearity is the maximum deviation between an ideal straight line measurement and the actual measurement. The more linear a sensor is the more consistent and precise the sensing results.

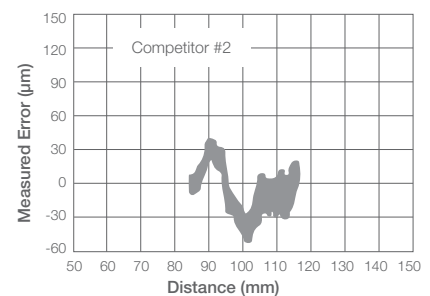
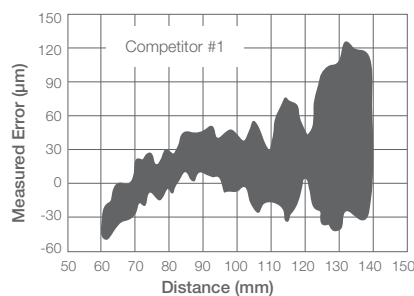
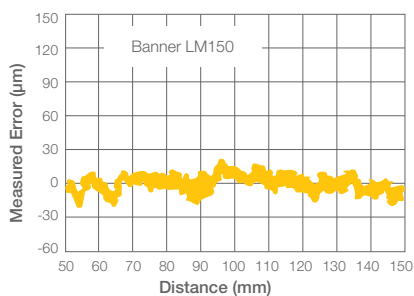

Example linearity on 90% white card

### Temperature Effect

A sensor with minimal temperature effect is critical for precise sensing applications since the induced error from just a few degrees of temperature shift can greatly impact sensors results.

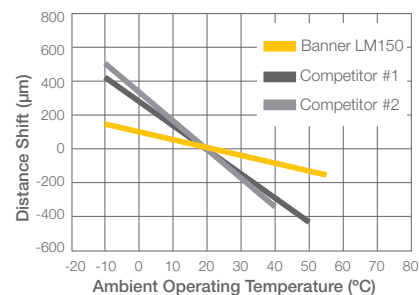

Example temperature effect at max range

# RSD

## Remote Sensor Display

- Can be used for initial setup by equipment manufacturers with the ability to copy settings across many sensors.
- Allows for configuration of remote sensor
- Easy to set up and use with a 2-line, 8-character display
- Display live distance measurement for remote monitoring
- Ability to save up to 6 unique configurations
- Not required for continuous operation of configured sensor(s)

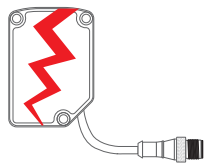

Simple device replacement with saved configurations

Ability to save up to 6 unique configurations for faster product changeover

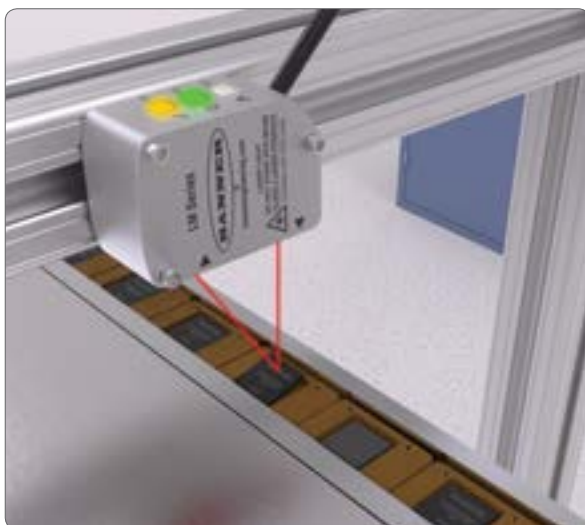
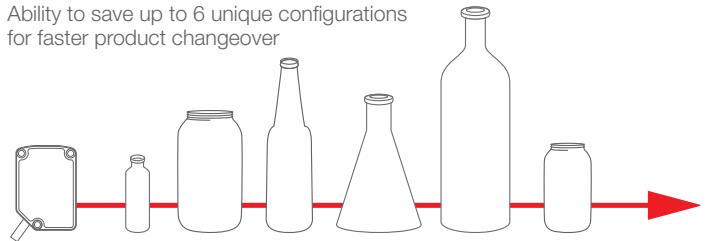

### Correct Orientation/Alignment

#### Challenge

IC chips can be slightly tilted in the nests – which creates a small distance change that is difficult to detect. They can also be seated in the nests, but placed upside down. Test stations have space limitations and do not have room for large vision systems or sensors.

#### Key Features

Resolution on the LM is able to detect 0.004 mm of height variation, even on black targets. The LM's Dual Teach mode, which measures distance and intensity, makes it able to distinguish contrast differences.

#### Key Benefits

The LM's precision allows it to catch if the chips are not seated completely in the nest, while the Dual Teach Mode can verify that the chip is right side up, providing a more reliable inspection and limiting false failures. The compact size of the LM is easy to integrate into the test fixture.



 IO-Link®

## Q4X Series

Versatile, Rugged, Laser Measurement Sensor

- Save time and money with the Q4X which is ready to measure right out of the box
- Four-digit display shows distance to target in mm
- FDA-grade stainless steel is suitable for IP69K washdown environments
- A simple user experience from installation to setup
  - Bright spot alignment
  - Three push buttons simplify setup
  - Intuitive menus

### Error-Proofing

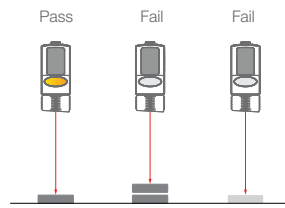

Distance	✓	✗	✓
Color	✓	✓	✗

### Measurement

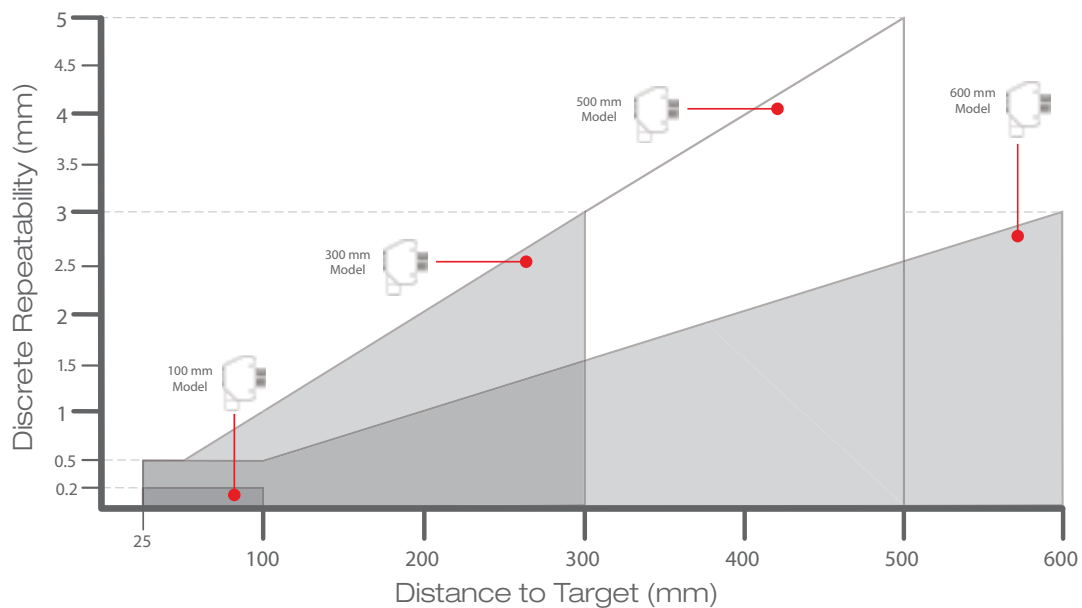
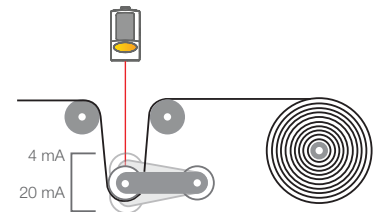



### Threaded-Barrel Q4XT

Example Model Number: Q4XTBLAF300-Q8

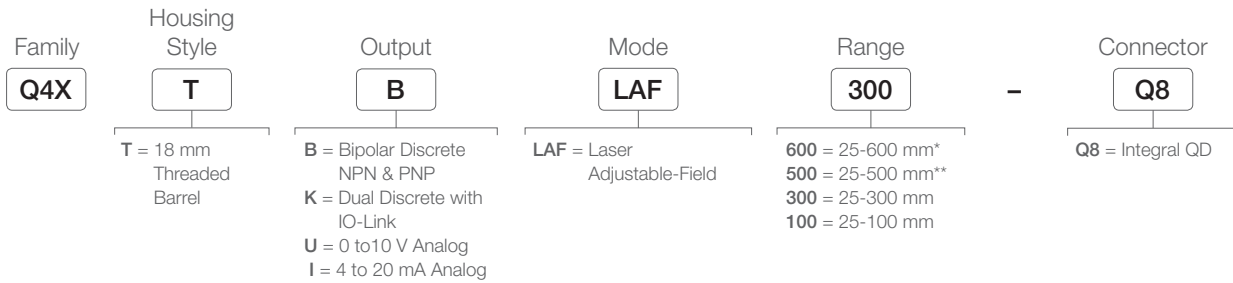

### Flush-Mount Q4XF

Example Model Number: Q4XFNLAF310-Q8

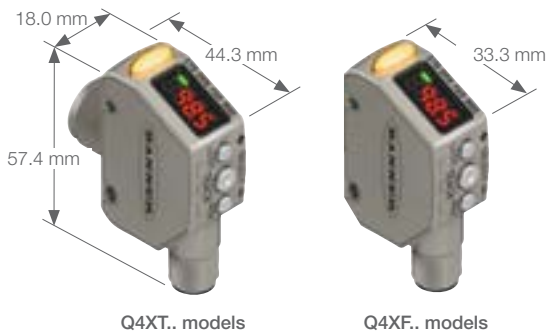
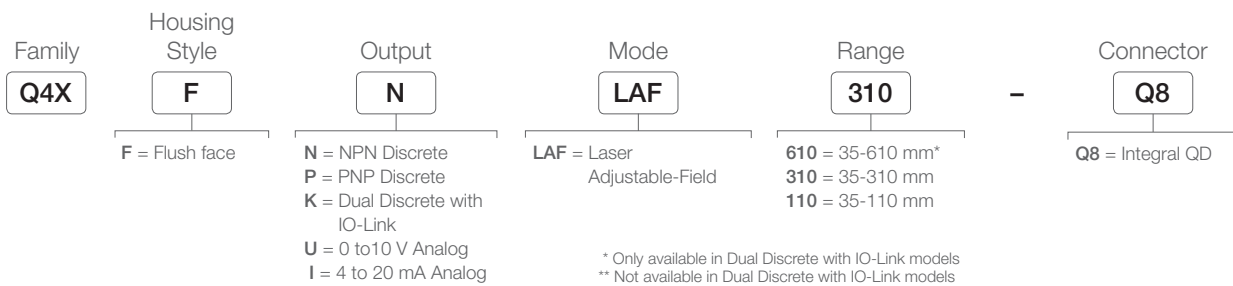



**IO-Link®**

## LE Series Laser Measurement Sensors

- Ready to measure right out of the box
- Easy adjustment with a two-line, eight-character intuitive display
- Repeatability and accuracy for challenging targets, from metal to black rubber
- Visible laser for small spot size and simple alignment

### Intuitive Display, Simple Adjustment

#### Setting Options:

##### 2-Point Teach

Teach two targets as the end points of the analog span or discrete output window

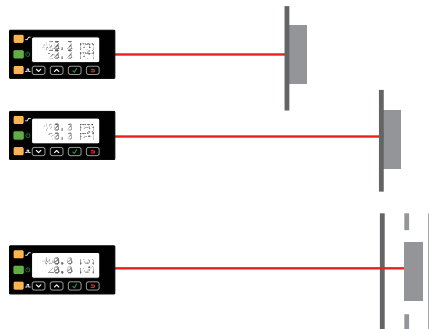

##### Mid-Point Teach

Teach a window of user-defined size around a target

##### Push Button Adjust

Manually set analog and discrete output end points without presenting a target

### Precision Laser Measurement

#### LE250

- Measurement Range up to 400 millimeters
- Resolution as fine as 0.02 millimeters
- Small laser spot for detecting small features and best performance across changing colors and reflectivity



#### LE550

- Measurement Range up to 1 meter
- Sub millimeter resolution across entire range
- Larger spot for better measurement stability across uneven surfaces

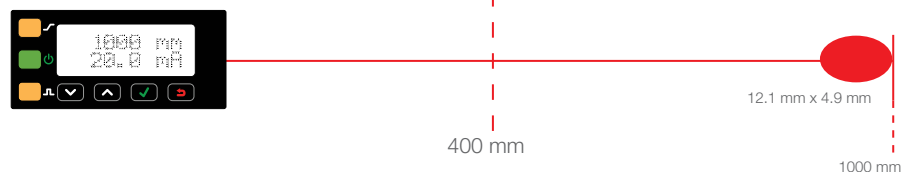





Family	Range	Output	Laser Class	Connector
<b>LE</b>	<b>550</b>	<b>I</b>	<b>Blank</b>	<b>Q</b>
	550 = 100-1000 mm 250 = 100-400 mm	I = 4 to 20 mA analog and (1) NPN/PNP discrete U = 0 to 10 V analog and (1) NPN/PNP discrete D = (2) NPN/PNP discrete K = IO-Link and (1) PNP discrete	Blank = Class 2 C1 = Class 1	Blank = 2 m Integral Cable Q = Rotatable M12 Euro QD  QD models require mating cordset

NOTE: Discrete NPN/PNP is user configurable

## LTF Series Laser Measurement Sensor

- A powerful long-range distance measuring sensor with advanced functions including:
  - Remote teach
  - High excess gain for seeing really dark targets
  - Laser power control for accurately measuring shiny targets
  - Laser inhibit
  - Cross-talk avoidance
  - Fast response speed
  - Delay timers
- Sensing range of 50 mm to 24 m
- Durable housing rated IP67
- Superior resistance to ambient light sources



### Best-in-Class Combination of Repeatability and Range

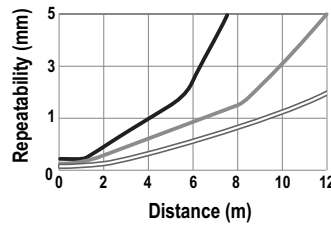

The LTF detects dark targets at 11 meters and white targets at 24 meters with repeatability <5 millimeters



## Time-of-Flight Measurement

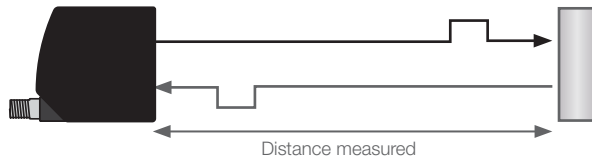

The LTF sensor uses time-of-flight measurement, emitting a pulsed light and measuring the amount of time for the light to reflect off the object and return to the sensor to calculate the distance. This enables sensing in long-range applications across a wide variety of targets.

## Long Range Measurement Applications

- Roll diameter
- Loop control
- Automated storage
- Presence/absence
- Palletizer
- Transfer press
- Robot end effector
- Fill Level



Monitoring levels inside a high-volume hopper

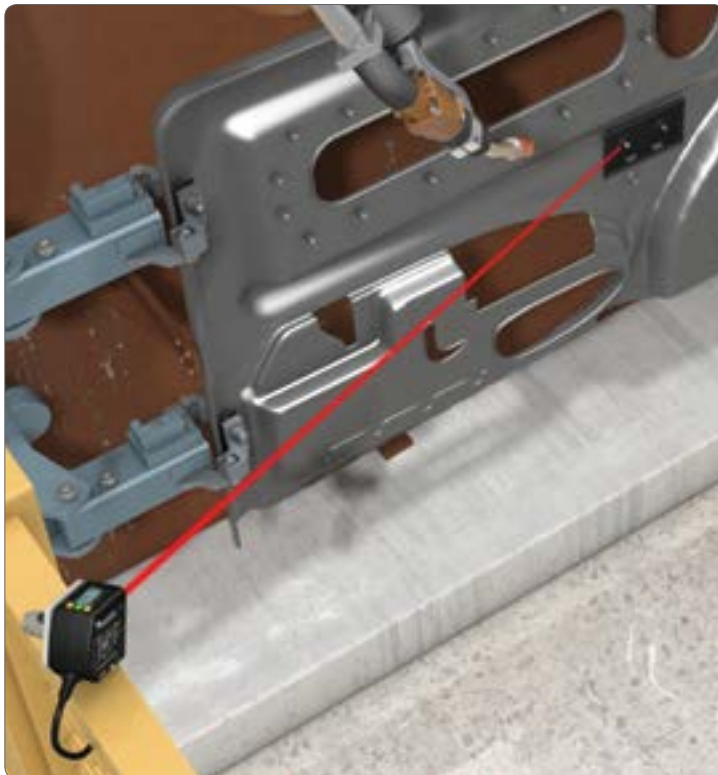

Detecting black parts on a shiny background



Loop control on a calendering machine

## QS18 Series

### Versatile Sensor for Global Manufacturing Needs



- All-purpose sensors solve the widest variety of sensing applications
- Versatile sensor with many mounting options
- Meets IP67 and NEMA 6 standards for use in harsh environments
- Right-angle barrel- and side-mount sensors
- Bright LEDs visible from 360 degrees



#### QS18 Standard

The QS18 Standard Sensor requires little to no adjustment. The sensor is available in multiple sensing modes and has a wide variety of connection options.



IO-Link®

#### QS18 Expert™

The QS18 Expert™ offers advanced sensing with single push-button programming and several sensing modes and configuration options.



IO-Link®

#### QS18 Clear Object

The QS18 Clear Object sensor is designed for clear object detection in plastic or glass containers.



#### QS18 Laser

The QS18 Laser Sensor has a narrow visible beam spot for easy alignment and small object detection.



#### QS18 Adjustable-Field

The QS18 Adjustable-Field Sensor is ideal for background and foreground suppression. The sensor is available in long-range models for sensing up to 300 mm.



IO-Link®

#### QS18 Electronic Adjustable Field

The newest addition to the popular QS18 Series family is an electronic adjustable field background suppression sensor with barrel mount. Electronic adjustment provides a more robust optical design by eliminating moving parts, such as lenses.



#### QS18 Universal Voltage

The QS18 Universal Voltage Sensor operates on ac or dc voltage and has several sensing modes available, making it an ideal sensor for many manufacturing environments.

# QS30 Series

## High-Performance, Long-Range Sensors

- Right-angle, barrel- and side-mount sensors
- Specialized models for reliable detection of water or liquids containing water
- Specialized photoelectric sensors that have the ability to differentiate colors in low contrast applications



**QS30 Standard**

Eight sensing modes for solving most applications: opposed, retroreflective, convergent, diffuse, plastic and glass fiber optic, and adjustable-field and fixed-field. High-performance sensing with visible, long-range Class 1 and 2 lasers with narrow effective beam for small object detection and precise position control.



**QS30 Expert™**

Single push-button programming with five advanced sensing options for reliable detection of reflective objects and resolves slight contrast differences.



**QS30 Water Detection**

The QS30 Water Sensors have an infrared wavelength that is tuned to the absorption band of water.



**QS30 Adjustable-Field**

Background suppression models for detection of objects when the background condition is not fixed, and foreground suppression models for detection when background is fixed and object varies in color or shape.



**QS30 Universal Voltage**

Compact ac or dc powered sensor can be used in almost any mounting configuration, including 30 mm barrel, base or side mounting.



## Q12 Series

### Miniature Self-Contained Sensors

- Sets a new industry standard for ultra-miniature photoelectric sensors delivering powerful sensing performance in extremely confined areas
- Features a housing just 22 by 8 by 12 mm, with bipolar NPN/PNP outputs; Rated IP67 for use in the widest range of locations and applications
- Available in opposed, fixed-field, and polarized and non-polarized retroreflective sensing modes; dark- or light-operate models
- Available in models with rugged, sealed housing or PFA chemical-resistant jacket
- Mounts directly on or inside manufacturing equipment, with robust metal-lined mounting holes
- Uses unique overmolded design for enhanced durability and shielding



## Q20 Series

### Industry Standard Global Housing

- Available in opposed, polarized and non-polarized retroreflective, diffuse, and electronic adjustable field models
- Offers visible red beam for easy alignment on most models
- Features bright LED status indicators visible from 360°
- Provides water-tight, IP67 and NEMA 6 rated enclosure for rugged, reliable sensing
- Offers 10 to 30V dc supply voltage with complementary NPN or PNP outputs, depending on model
- Provides versatile mounting options, including M3 (3 mm) threaded inserts with 25.4 mm hole spacing
- Includes single-turn gain potentiometer for easy configuration, depending on model

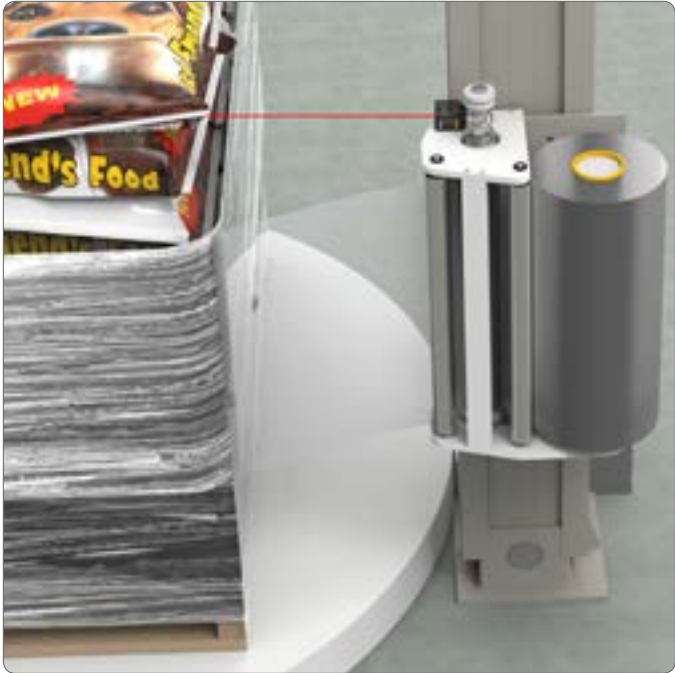

Dog food pallet detection using Q5X



Wafer detection using the VS8



Auto seat adjustment measurement using the LE550

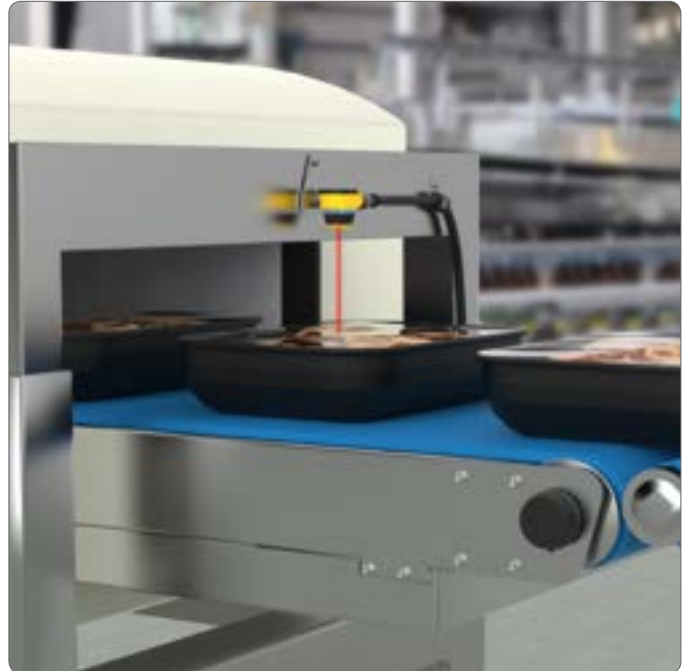

Detection in a washdown environment using a T18-2







# Machine Safety

Designed to be easy to use and implement, developed to protect personnel and equipment from accident and injury, and built to perform reliably in challenging environments, our comprehensive collection of machine safety products provide the highest levels of safety without compromising productivity.

# Selection Guide | Safety Light Curtains

Safety light curtains protect personnel from injury and machines from damage by creating a sensing screen that guards machine access points and perimeters. Banner offers intuitive, easy-to-use safety light curtains for a wide variety of safety applications.

Type 4 safety light curtains protect personnel from injury and machines from damage by guarding points of operation, access, areas and perimeters. Type 2 safety light curtains are a cost-effective light curtain safety solution for guarding lower-risk applications, where the result of an accident is only a slight injury.













Series		Max Sensing Range (m)	Defined Area (mm)	Dimensions H x W x D (mm)	Safety Rating	Special Considerations	Page # or Web
HEAVY DUTY	EZ-SCREEN® LS	12	280 to 1820	H (varies by model) 36 x 45	Type 4 Category 4/PLe SIL3; SIL CL3		46
	EZ-SCREEN® LS Basic	8	350 to 1820	H (varies by model) 36 x 45	Type 4 Category 4/PLe SIL3; SIL CL3		47
	EZ-SCREEN®	18	150 to 2400	H (varies by model) 36 x 45	Type 4 Category 4/PLe SIL3; SIL CL3		
	SGS Grids	60	up to 1200	H (varies by model) 52 x 57	Type 4 Category 4/PLe SIL3; SIL CL3		51 Active/Passive
COMPACT	EZ-SCREEN® LP	7	270 to 1250	H (varies by model) 28 x 26	Type 4 Category 4/PLe SIL3; SIL CL3		48
	EZ-SCREEN® LP Basic	4	270 to 690	H (varies by model) 28 x 26	Type 4 Category 4/PLe SIL3; SIL CL3		49
	SLC4	2	160 to 320	H (varies by model) 27 x 22	Type 4 Category 4/PLe SIL3; SIL CL3		50
	EZ-SCREEN® Type 2	15	150 to 1800	H (varies by model) 25 x 32 mm	Type 2 Category 2/PLc		

**KEY**

- Finger Detection
- Hand Detection
- Ankle Detection
- Body Detection
- Muting Option
- Cascadable
- Indicator Capable





# Emergency Stop

Emergency stop devices provide workers a means of stopping a device during an emergency by pushing a button or pulling a rope in order to prevent injury to personnel and material loss.





Series	Mounting	Environmental Rating	Dimensions H x W x D (mm)	Special Considerations	Page # or Web
 30 mm Mount E-Stop Button	30 mm	IP65 IP69 available	120 x ø 80	 	53
 Flush Mount E-Stop Button	Flush Mount	IP65	H (varies by model) x 81 x 80	  	53
 Panel Mount E-Stop Button	Panel Mount	IP65	ø 40, ø 44, and ø 60 mm	 	
 Rope Pull	Flush Mount	IP67	Dimensions vary by model	Metal or plastic Up to 75 m rope length	

# Safety Laser Scanners

Safety laser scanners provide a solution for safeguarding mobile vehicles and stationary applications, such as the interior of robotic work cells that cannot be solved by other safeguarding solutions.

Series	Range		Scanning Angle	Dimensions H x W x D (mm)	Special Considerations	Page # or Web
	Protective Field	Warning Field				
 SX5	up to 5.5 m	40 m	275°	152 x 112 x 102	 	52
 AG4	up to 6.2 m	15 m	190°	130 x 148 x 135		

**KEY**

-  Illuminated
-  Lockable
-  Cascadable
-  LCD Display
-  Muting

# Selection Guide | Safety Relays and Controllers

Industrial safety controllers and relays provide an interface between safety devices and the machines and processes those devices monitor for a complete and easy-to-use safety control solution.



Safety Relays



Hybrid Safety Controller plus 2 Safety Relays



Expandable Safety Controller

Cost effective for simple safety circuits

- Pre-set Functionality: Configuration not required
- Safety Inputs: 1
- Independently controlled Safety Outputs: 1, 4 to 7A

Flexible and cost effective solution for machines typically using 2 Safety Relays

- PC Configurable: Flexible and easy-to-use
- Safety Inputs: up to 10
- Independently controlled Safety Outputs: 2, 6A each
- Convertible Safety Inputs: 4
- Terminal LEDs for easy troubleshooting
- Industrial Ethernet

EtherNet/IP Modbus PCCC

Expandable for Complex Safety applications where 3 or more safety relays are typically use

- PC Configurable: Flexible and easy-to-use
- Safety Inputs: 26 (base unit) up to 154
- Independently controlled Safety Outputs: up to 68, 0.5A to 6A each
- Convertible Safety Inputs: 8 (Base Unit) up to 40
- LCD Display for easy troubleshooting
- Industrial Ethernet





















EtherNet/IP Modbus PCCC

## SC10 and SC/XS26 PC Configuration Software

The feature-rich SC10 and SC/XS26 safety controller software provides a seamless user interface for setting up and managing safety systems. The software features an intuitive icon-based, drag-and-drop user interface to reduce the learning curve and speed up commissioning.

- Complex configurations made easy
- Simulate configurations before implementation
- Auto configure industrial ethernet for remote monitoring and diagnostics

Start using the free software today. Go to [www.bannerengineering.com/safetycontroller](http://www.bannerengineering.com/safetycontroller)

	Series	# of Safe Inputs	Independently Controlled Safe Outputs	Max. Safety Output Rating											
CONFIGURABLE SAFETY CONTROLLERS	 XS26	up to 154*	up to 68*	0.5A, 6A* ea.	✓	✓	✓	✓	✓	✓	✓	✓	✓	✓	
	 SC26	up to 26	2	0.5A ea.	✓	✓	✓	✓	✓	✓	✓	✓	✓	✓	
	 SC10	up to 10	2	6A ea.	✓	✓	✓	✓	✓	✓	✓	✓	✓	✓	
PRE-CONFIGURED SAFETY RELAY MODULES	 SR	1	1	6A				✓							
	 IM	1	1	6A				✓							
	 ES	1	1	7A	✓	✓				✓					
	 UM	1	1	7A	✓	✓	✓	✓	✓	✓					
	 GM	1	1	6A					✓						
	 SM	1	1	6A							✓				
	 AT Two-Hand	2 STB	1	6A								✓			
	 MMD	2	1	6A	✓	✓	✓	✓		✓			✓		

NOTE: Up to Cat. 4 PL e. per EN ISO 13849-1; SIL 3 per IEC 61508 and IEC 62061. See [www.bannerengineering.com](http://www.bannerengineering.com) for additional information.

\* Expandable input and output modules available

# Selection Guide | Safety Switches

Safety switches respond when a mechanical guard is opened. They feature “positive opening” contacts for high reliability regardless of environmental conditions and withstand attempts to override the switch and defeat the system.



## Non-Contact Switches

- Two piece design where sensor and actuator do not contact
- In-Series Diagnostics (ISD) provides users with data from each sensor in a cascade chain
- Cascade up to 32 sensors while achieving the highest level of safety
- Accommodating to misalignment
- IP69 solutions available
- Available with the highest level of tamper resistance



## Hinge Switches

- One piece sensor and actuator with hinge function
- Fast installation and set-up with repositionable safety switch point
- Stainless steel and IP69 available
- Matching hinges without sensing available for additional door support
- Available with up to 270° safety switch point operation range



## Mechanical Switches

- Two piece design with mechanical operator feedback
- Flexible actuator options for misalignment
- Rotatable heads for flexible installation
- Mechanically coded actuator to minimize tampering
- Up to 15N latching force







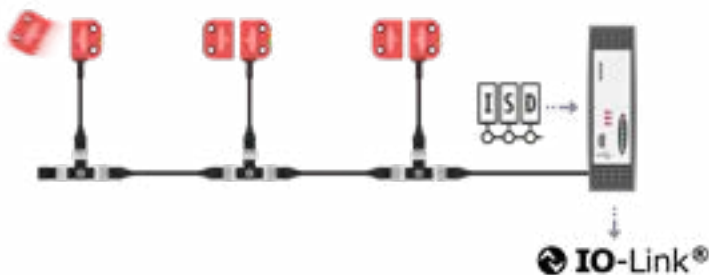























## Locking Switches

- Two piece design with up to 2000N holding force
- Flexible actuator options for misalignment
- Rotatable heads for flexible installation
- Mechanically coded actuator to minimize tampering
- Up to 15N latching force



In-Series Diagnostics (ISD) provides users with status and performance data from each sensor in a cascade chain. The ISD data collected is converted to IO-Link so it can be accessed with an HMI or similar device. Users receive notification when an event has occurred as well as where in the series the event occurred. Events include the opening or closing of a door, door misalignment, wrong actuator taught, and a number of switch health attributes.

Series	Switch Technology	Environmental Rating	Tamper Resistance- Coding Level	Safety Rating (single sensor)	Assured On Sac/ Misalignment Tolerance (mm)	# of Cascaded Sensors at Ple/Cat4	Non-Contact	Position Monitoring	LED Status Indication	ISD (In-Series Diagnostics)	Locking (1K to 2K N Holding Force)	Latching (~10N Force)
	SI-MAG	Mag	IP65	Low	Ple/Cat 4	3-5						
	SI-RF Non- Cascade	RFID	IP69	Low High Unique	Ple/Cat 4	10						
	SI-RF Cascade	RFID	IP69	Low High Unique	Ple/Cat 4	10	32					
	SI-RF Cascade and ISD	RFID	IP69	Low High Unique	Ple/Cat 4	10	32					
	SI-HG63	Mech	IP67 & IP69 Stainless Steel	Low	up to Ple/ Cat 4*							
	SI-HG80	Mech	IP65	Low	Ple/Cat 3**							
	SI-LS31	Mech	IP65	Low	Ple/Cat 3**							
	SI- LS100/83	Mech	IP65	Low	Ple/Cat 3**							
	SI- QS90/75	Mech	IP65	Low	Ple/Cat 3**							
	SI-LM40	Mech	IP65 Metal	Low	Ple/Cat 3**							
	SI-LS42	Mech & Solenoid Locking	IP65	Low	Ple/Cat 3**							
	SI-QM100	Mech & Solenoid Locking	IP65 Metal	Low	Ple/Cat 3**							

\* Dual Switch Hinge model or applicable second safety switch added for Ple/Cat 4  
 \*\* Ple/Cat 4 achieved with applicable second safety switch added



## LS Series

### Full Feature Heavy-Duty Type 4 Safety Light Curtain

EZ-SCREEN® LS light curtains are easy-to-use safety devices with an advanced feature set for a wide range of applications. They are built to withstand challenges commonly found in manufacturing and packaging environments.

- Full featured models with options to meet a wide range of applications
- Heavy-duty aluminum housing and recessed window to avoid damage in harsh environments
- End-to-end sensing (no blind zone)
- Highly visible alignment and diagnostic indicators
- 14, 23 & 40 mm resolution (detection capability)
- Available in 23 defined area heights from 280 to 1820 mm in 70 mm increments
- 12 m maximum sensing range
- External device monitoring, auxiliary fault options and scan code select included (with 8-pin connectors)
- Automatic configuration (No DIP switches)
- IP65/IP67 environmental rating with IP69 models available
- Cascade capable models available
- Remote fixed blanking to ignore stationary objects
- Optional status indicator or fixed blanking control with cascade models
- Brackets and M12 QD pigtails included

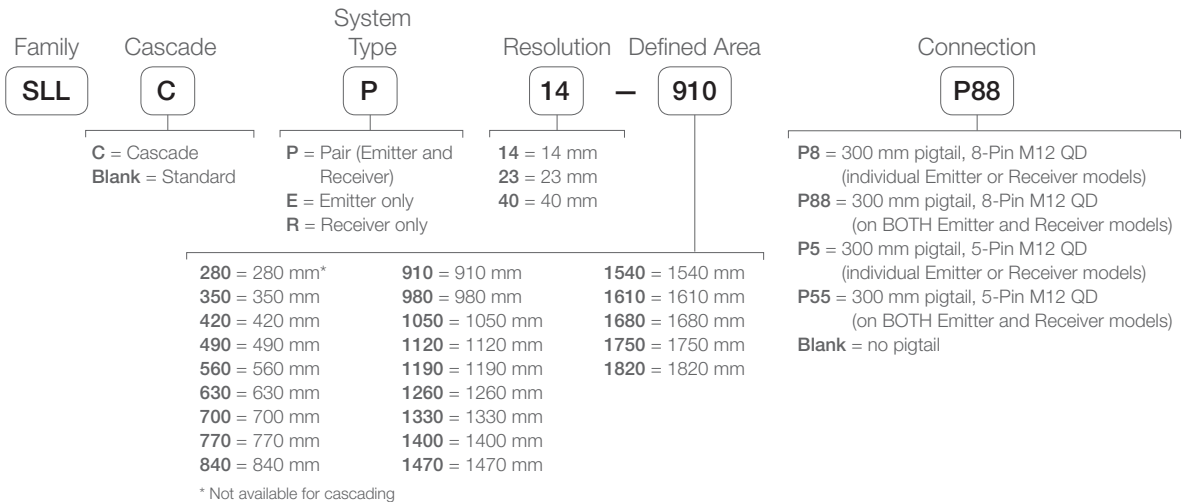

IP69 Hygienic Option Available



## LS Basic Series

### Basic Feature Heavy-Duty Type 4 Safety Light Curtain

The EZ-SCREEN® LS Basic Series offer the same rugged construction as standard LS light screens with a basic feature set.

- Basic models with limited options offer additional value for simple applications
- Heavy-duty aluminum housing and recessed window to avoid damage in harsh environments
- End-to-end sensing (no blind zone)
- Highly visible alignment and diagnostic indicators
- 23 mm resolution (detection capability)
- Available in ten defined area heights from 350 to 1820 mm
- 8 m maximum sensing range
- External device monitoring, auxiliary fault options and scan code select included (with 8-pin connectors)
- Automatic configuration (No DIP switches)
- IP65/IP67 environmental rating
- Brackets and M12 pigtails ordered separately



**M12 Pigtail**  
Euro-Style Quick Disconnect to LS Custom Male Straight Connector

**DELSE-51D (5-pin)**  
0.3 m (1 ft)

**DELSE-81D (8-pin)**  
0.3 m (1 ft)



## LP Series

### Full Feature Compact Type 4 Safety Light Curtain

The space-saving, compact profile of the EZ-SCREEN® LP is ideal for smaller machines with an advanced feature set for a wide range of applications .

- Full featured models with options to meet a wide range of applications
- Low-profile, compact aluminum housing for smaller production machines
- End-to-end sensing (no blind zone)
- Highly visible alignment and diagnostic indicators
- Available in 14 or 25 mm resolutions (detection capability)
- 8 defined areas from 270 to 1250 mm in 140 mm increments
- 7 m maximum sensing range
- External device monitoring, auxiliary fault outputs, latching, blanking and scan code select included
- Available in nickel-plated housings for ESD-safe applications, clear anodized aluminum housing or “safety” yellow powder-coat housing
- Cascade capable models and models with integral muting available
- Brackets and M12 QD pigtails included

Family	Cascade/ Muting	System Type	Resolution	Defined Area	Finish	Connection
<b>SLP</b>	<b>C</b>	<b>P</b>	<b>14</b>	— <b>410</b>		<b>P88</b>
	<b>C</b> = Cascade* <b>M</b> = Integral Muting <b>Blank</b> = Standard	<b>P</b> = Pair (Emitter and Receiver) <b>E</b> = Emitter only <b>R</b> = Receiver only	<b>14</b> = 14 mm <b>25</b> = 25 mm	<b>270</b> = 270 mm** <b>410</b> = 410 mm <b>550</b> = 550 mm <b>690</b> = 690 mm <b>830</b> = 830 mm	<b>970</b> = 970 mm <b>1110</b> = 1110 mm <b>1250</b> = 1250 mm	<b>Blank</b> = Yellow powder coat <b>N</b> = Nickel-plated ESD <b>A</b> = Clear anodized aluminum
<b>P8</b> = 300 mm pigtail, 8-Pin M12 QD (individual Emitter or Receiver models) <b>P88</b> = 300 mm pigtail, 8-Pin M12 QD (on BOTH Emitter and Receiver models) <b>P5</b> = 300 mm pigtail, 5-Pin M12 QD (individual Emitter or Receiver models) <b>P55</b> = 300 mm pigtail, 5-Pin M12 QD (on BOTH Emitter and Receiver models) <b>Blank</b> = no pigtail, RD connection (for RDLS-8..D or RDLS-5..D cordset)						

\* 8-pin Connection required for cascade models and to enable EDM, Aux Output and Reset features

\*\* Not available for cascading

## LP Basic Series

### Basic Feature Compact Type 4 Safety Light Curtain

LP Basic Safety Light Curtains offer the same compact construction of the full feature LP, with a basic feature set.

- Basic models with limited options offer additional value for simple applications
- Low-profile, compact aluminum housing for smaller production machines
- End-to-end sensing (no blind zone)
- Highly visible alignment and diagnostic indicators
- Available in 14 or 25 mm resolutions (detection capability)
- Defined areas of 270, 410, 550, or 690 mm
- 4 m maximum sensing range
- Brackets and M12 QD pigtails included

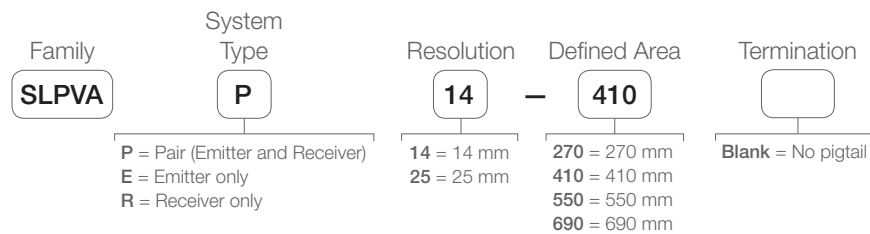
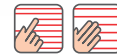

**"RD" to M12 Pigtail**  
Euro-Style M12 Male QD to LP Custom "RD" Connector

<b>DELPE-51D (5-pin)</b> 0.3 m (1 ft)	<b>DELPE-81D (8-pin)</b> 0.3 m (1 ft)
--	--



## SLC4 Series

Basic Feature, Very Compact Type 4 Safety Light Curtain

SLC4 safety light curtains are our shortest, most compact safety light curtains. They are designed to safeguard points of access and operation on smaller production machines and similar equipment.

- Basic models with limited options for additional value on simple applications
- Very compact aluminum housing with IP65 polycarbonate enclosure for smaller production machines
- End-to-end sensing (no blind zone)
- Highly visible alignment and diagnostic indicators
- Available in 14 or 24 mm resolutions (detection capability)
- Defined areas of 160, 240 and 320 mm
- 2 m maximum sensing range
- Integral 300 mm M12 QD Pigtail included
- Brackets sold separately



Family	System Type	Resolution	Defined Area	Termination
<b>SLC4</b>	<b>P</b>	<b>14</b>	— <b>160</b>	<b>P44</b>
	P = Pair (Emitter and Receiver) E = Emitter only R = Receiver only	14 = 14 mm 24 = 24 mm	160 = 160 mm 240 = 240 mm 320 = 320 mm	P4 = 300 mm pigtail, 4-Pin M12 QD (individual Emitter or Receiver models) P44 = 300 mm pigtail, 4-Pin M12 QD pigtails (Pair)

## SGS Series

### Safety Grid System

SGS Safety Grid Systems are cost-effective multiple beam safety light devices for access and long-range perimeter guarding applications. They are available in Emitter/Receiver models capable of safeguarding over very long distances and in easy-to-deploy Active/Passive models that offer additional cost savings.

- Models available with integral muting for entry/exit conveyors or palletizing cells
- Heavy-duty aluminum housing for tough environments
- Easy alignment and installation with on-board alignment lamp and indicators
- Protective heights of 500, 800, 900, or 1200 mm available
- Up to 60 m range available for perimeter guarding applications
- Mute arm kits available to simplify end-of-line packaging applications



### Mute Arm Kits

Pre-assembled (with mounting hardware) for plug-and-play connection to the SGS grid and LS Safety Light Curtains



**SGSA-ML-L-LPQ20** (left) **SGSA-ML-R-LPQ20** (right)  
includes 2 mute arms, 2 SGSA-Q20PLPQ5 mute sensors, and 2 retroreflectors

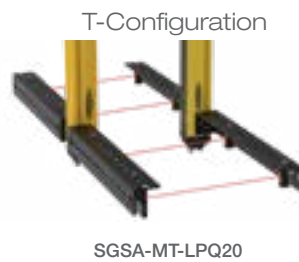

**SGSA-MT-LPQ20**  
includes 4 mute arms, 4 SGSA-Q20PLPQ5 mute sensors, and 4 retroreflectors



**SGSA-MX-LPQ20**  
includes 4 mute arms, 2 SGSA-Q20PLPQ5 mute sensors, and 2 retroreflectors

### Emitter & Receiver

Type	Protective Height (mm)	Range (m)	Model
Emitter & Receiver	500 (2 beams)	6 to 60	SGSXP2-500Q88
	800 (3 beams)		SGSXP3-400Q88
	900 (4 beams)		SGSXP4-300Q88
	1200 (4 beams)		SGSXP4-400Q88
Emitter & Receiver	500 (2 beams)	0.5 to 30	SGSSP2-500Q88
	800 (3 beams)		SGSSP3-400Q88
	900 (4 beams)		SGSSP4-300Q88
	1200 (4 beams)		SGSSP4-400Q88
Emitter & Receiver with Integral Muting	500 (2 beams)	0.5 to 30	SGSMP2-500Q128
	800 (3 beams)		SGSMP3-400Q128
	900 (4 beams)		SGSMP4-300Q128
	1200 (4 beams)		SGSMP4-400Q128

### Active (requires Passive Mirror)

Type	Protective Height (mm)	Range (m)	Model
Active Transceiver	500 (2 beams)	0.5 to 8	SGSSA2-500Q8
	800 (3 beams)	0.5 to 8	SGSSA3-400Q8
	900 (4 beams)	0.5 to 6.5	SGSSA4-300Q8
	1200 (4 beams)	0.5 to 8	SGSSA4-400Q8
Active Transceiver with Integral Muting	500 (2 beams)	0.5 to 8	SGSMA2-500Q12
	800 (3 beams)	0.5 to 8	SGSMA3-400Q12
	900 (4 beams)	0.5 to 6.5	SGSMA4-300Q12
	1200 (4 beams)	0.5 to 8	SGSMA4-400Q12

### Passive Mirror

Type	Protective Height (mm)	Range (m)	Model
Passive Mirror Assembly	500 (2 beams)	Pair with Active Transceivers with matching beams and protective heights	SGSB2-500
	800 (3 beams)		SGSB3-400
	900 (4 beams)		SGSB4-300
	1200 (4 beams)		SGSB4-400

## SX5-B Safety Scanner System



- Maximum ranges for Safety Zone is 5.5 m and Warning Zone is 40 m
- 275 degrees of coverage makes it easy to safeguard a corner
- Dynamic Muting available and selectable detection capability for vertical applications
- Configurable for up to 6 zone sets
- Light Immune and dust resistant

Rugged design for reliable industrial use

27 different status, diagnostic, warning and error displays



Keypad

M12 Ethernet connector cover



- LED 1: Object Detection in Safety Zone (OSSD)
- LED 2: Not Available
- LED 3: Assigned to Warning Zone 2
- LED 4: Assigned to Warning Zone 1
- LED 5: Interlock Status (waiting for Reset)

### Software

Communication between a PC and the SX5 via an Ethernet network. The SX5 is preprogrammed at the factory with a default configuration but must be reconfigured for each application.

- Administrative data: example file name, application description etc.
- Safety-relevant data: startup process information
- Safety Zone or Warning Zone configuration data: contours and limits

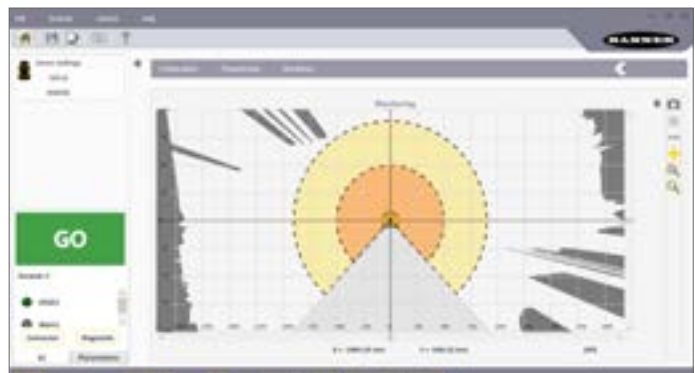

## Illuminated E-Stop Buttons

Patent pending highly visible illuminated base allows for easy identification of the status (armed, depressed/latched) of an individual e-stop or cascaded chain of e-stops to minimize downtime.

- Highly visible illuminated base shows armed status (off, green or yellow) and depressed/latched status (Red solid or flashing)
- Cascaded multiple illuminated e-stops for quick identification of armed state (all are yellow or green) or the e-stop that was pressed (red flashing) with the others in the chain red solid.
- Reduce installation time and cost with the Integral M12 QD and cascade connection accessories for plug-and-play connection
- Rugged design rated to IP65 with IP69 rated accessories available.
- Multiple size (40, 44, and 60 mm) and mounting configurations (30 mm and flush) available
- Latching design complies with ISO 13850 direct (positive) opening operation per IEC 60947-5-1



## Self-Checking Touch Buttons (STB)

- Provides highest level of safety for two-hand control input devices when combined with Banner AT Safety Module or Safety Controller
- Responds to a finger blocking light rather than to pressure to reduce fatigue
- Features ergonomic design to prevent repetitive motion stress
- Includes yellow field cover to prevent unintended switching
- Withstands exposure to a variety of chemicals, depending on model



## Two-Hand Control Runbar

- Provides a convenient and economical means for two-hand control actuation when interfaced with DUO-TOUCH® SG Two-Hand Control Modules or Banner Safety Controller
- Offers ergonomic design for reduced hand, wrist and arm stress
- Offers model with emergency stop button and provides knockouts for wiring flexibility and installation of accessory EZ-LIGHT™ indicators
- Offers optional telescoping stands and brackets







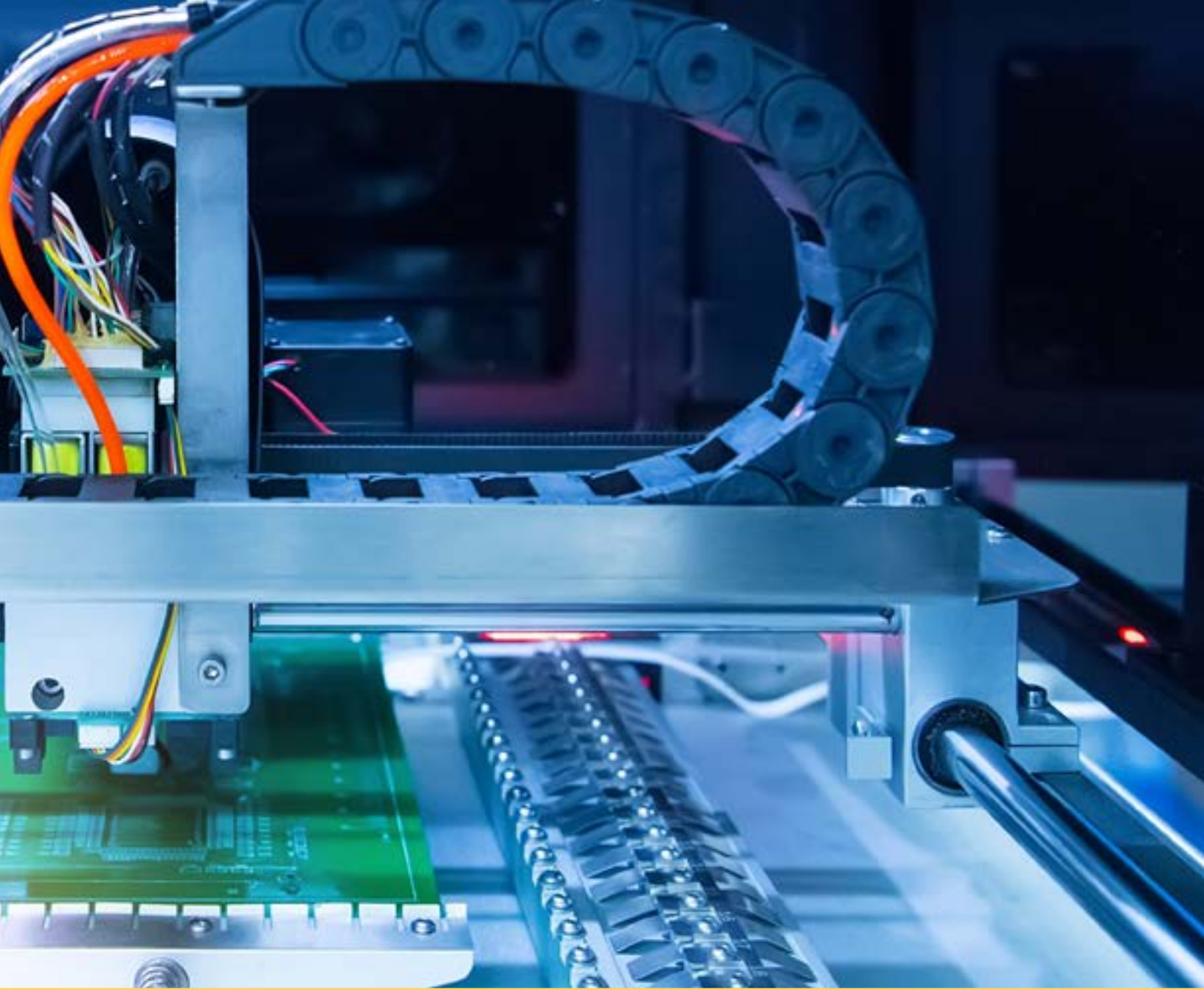

# Machine Vision

Vision sensors, smart cameras, and vision lights from Banner combine high performance tools, intelligent features, and an intuitive user interface. They are cost-effective, easy-to-deploy, easy-to-use solutions capable of solving thousands of applications, from simple feature verification to complex, high-speed inspections. Banner's vision software and firmware updates are always available for full download free of charge.

# Selection Guide | Vision Sensors and Cameras

## Vision Sensors

Robust yet easy-to-use self-contained vision sensors perform automated inspections that previously required costly and complex vision systems.

Series	Configuration Options	Sensors	Imager	Integrated Lighting	Communications	Page # or Web
 iVu	Touchscreen, PC	Match Area Blemish Sort	WVGA (752x480) Grayscale	Red Blue Green White UV365 UV395 Infrared	EtherNet/IP™ Modbus/TCP PROFINET® PCCP RS-232	58
 iVu Color	Touchscreen, PC	Average Color Color Area Color Compare Match Area Blemish Sort	WVGA (752x480) Color	White	EtherNet/IP™ Modbus/TCP PROFINET® PCCP RS-232	58
 iVu BCR	Touchscreen, PC	2D Barcodes 1D Barcodes	WVGA (752x480) Grayscale	Red Blue Green White UV365 UV395 Infrared	EtherNet/IP™ Modbus/TCP PROFINET® PCCP RS-232	58

## Smart Cameras

Smart cameras are easy-to-use and offer powerful inspection tools and capabilities to solve a broad range of applications.

Series	Configuration Options	Tools	Imager	Integrated Lighting	Communications	Page # or Web	
 VE	PC	BLOB Bead Locate Match Math Line Detect Circle Detect Average Gray	Edge Blemish Logic Measure Object	WVGA (752x480) 1.3 MP (1280x1024) 2 MP (1600x1200) 5 MP (2592x2048) Grayscale	Lights Sold Separately	EtherNet/IP™ Modbus/TCP PROFINET® PCCP RS-232	60

# Vision Lighting

Vision lighting is the key to creating all-important contrast between the feature of interest and its background.

Lighting Technique	Description	Series	Page # or Web
 <p>Backlight</p>	<p>The part being inspected is placed between the camera and a bright, even light source. The result creates a silhouette of the target which is useful in edge detection, part presence and measurement applications.</p>	 <p>Backlights Linear Array Backlights</p>	
 <p>Ring Light</p>	<p>A ring light is affixed to the camera and both items can be mounted as one piece for convenience. This setup is good for relatively small parts or close up applications.</p>	 <p>Ringlights</p>	
 <p>Directional Light</p>	<p>Directional lights create shadows to detect changes in depth, illuminate specific surface angles, and avoid glare of reflective surfaces when directed at an angle away from lens.</p>	 <p>Area Lights Ring Lights Linear Array Lights</p>	
 <p>Low Angle Ring Light</p>	<p>Also called a dark field illuminator, this specialty light has its LEDs mounted in a ring, pointing toward the part almost perpendicular to the camera's direction of view. Low Angle Ring lights create shadows and bright spots to detect changes in depth.</p>	 <p>Low-Angle RingLights</p>	
 <p>On-Axis</p>	<p>On-Axis, or coaxial, lights generates light that travels along the same axis as the camera's direction of view. The camera looks down from the top, through the On-Axis light, to the target part below. This technique can be use to eliminate shadows, inspect shiny object or inspect for height changes.</p>	 <p>On-Axis Lights</p>	
 <p>Structured Light</p>	<p>A laser line generator is an example of a structured lighting scheme. This technique uses a high quality, uniform laser line to infer the presence of a difficult to see target. As a three-dimensional part passes through the laser line's path, the image of the laser becomes distorted so the camera can detect the part.</p>	 <p>Laser Line Genrators</p>	



## iVu Series Vision Sensors

The iVu and iVu Color Vision Sensors are used to monitor parts for type, size, orientation, shape, location, and color or color variations. The following features are available:

- Configure in minutes using Vision Manager PC software, onboard touchscreen display or using remote touchscreen to access to hard to reach places
- All-in-one solution with camera, controller, lens, and light included in one package
- Inspect multiple features with a wide variety of grayscale or color tools
- Compact, rugged, IP67 housing available with a variety of integrated ring lights including red, blue, green, white, infrared or UV
- Interchangeable lenses, including C-mount, for maximum application flexibility
- Factory communications (EtherNet/IP™, Modbus/TCP, PROFINET®, PCCC and Serial RS-232) for integration on the manufacturing floor
- Ability to change parameters on the fly with full runtime editing to reduce costly downtime

Family	Touchscreen	Sensor Type	Ring Light Color	Lens (mm)
<b>IVU2P</b>	<b>TG</b>	<b>TG</b>	<b>R</b>	<b>04</b>
	TG = Integrated RG = Remote*	C = Color† G = Grayscale B = Barcode	R = Red B = Blue G = Green W = White I = Infrared 6 = UV365 9 = UV395 XC = C-mount** X = No Ring Light	04 = 4.3 06 = 6 08 = 8 12 = 12 16 = 16 25 = 25 Blank = No lens (only C-Mount)

\* Remote touchscreen or PC is required for set up and viewing of sensors with a remote touchscreen

\*\* Requires C-mount lens

† Color sensor only available in white, C-mount or no ringlight



Label detection using a Match Sensor



Hardware sortation using a Sort Sensor



Blister pack inspection using an Area Sensor



Cap verification using a Color Area Sensor



Detect flaws on web using a Blemish Sensor



Trim color verification using an Average Color Sensor



## VE Series Smart Camera

VE Series Smart Cameras solve a wide range of vision applications, such as item detection, part positioning, feature measurement and flaw analysis

- Available in 5MP (2592 x 2048 pixels), 2MP (1600 x 1200 pixels), 1.3MP (1280 x 1024 pixels), and WVGA (752 x 480 pixels) models, all with the same powerful inspection capabilities
- Runtime editing capability reduces costly downtime and the software emulator allows for offline building and troubleshooting of applications
- Factory communications (EtherNet/IP™, Modbus/TCP, PROFINET®, and Serial RS-232) for integration on the manufacturing floor
- Built to stand up to industrial environments

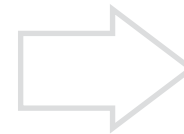
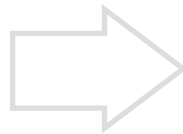

Select a camera resolution

Choose lens based on Field of View (FOV) and Working Distance (WD)

Optional filters create additional contrast

Accessories available at [www.bannerengineering.com](http://www.bannerengineering.com)

## Durable Design



Robust, aluminum housing for harsh environments

C-mount lens for a variety of applications

## Status and Troubleshooting



Bright LED indicators to easily view camera status

Two-line, eight-character display and push buttons for troubleshooting and viewing camera status

- Perform product change or trigger
- Troubleshoot and clear errors
- Change or view IP address, MAC address, or Ethernet speed
- View firmware, focus number or status

## Connections



Ethernet connector with Gigabit Ethernet communication speed

Discrete communication to external devices using five user-configurable optically isolated I/O

Power Banner vision lights directly from the camera



IP67 lens covers or ring lights available for additional protection

Family	Resolution	Imager	Ethernet Connection
<b>VE</b>	<b>202</b>	<b>G</b>	<b>1A</b>
	200 = WVGA, 752 x 480 pixels 201 = 1.3 MP, 1280 x 1024 pixels 202 = 2 MP, 1600 x 1200 pixels 205 = 5 MP, 2592 x 2048 pixels	G = Grayscale	1A = M12, 8-pin Euro-style female

# Machine Vision

## Vision Manager Software

Combining intuitive operation with powerful inspection tools, the Vision Manager software makes it easy for users of any experience level to solve challenging vision and barcode reading applications. The software is free, easy-to-use, and fully compatible with VE Series smart cameras, iVu Series vision sensors, and iVu barcode readers from Banner Engineering.

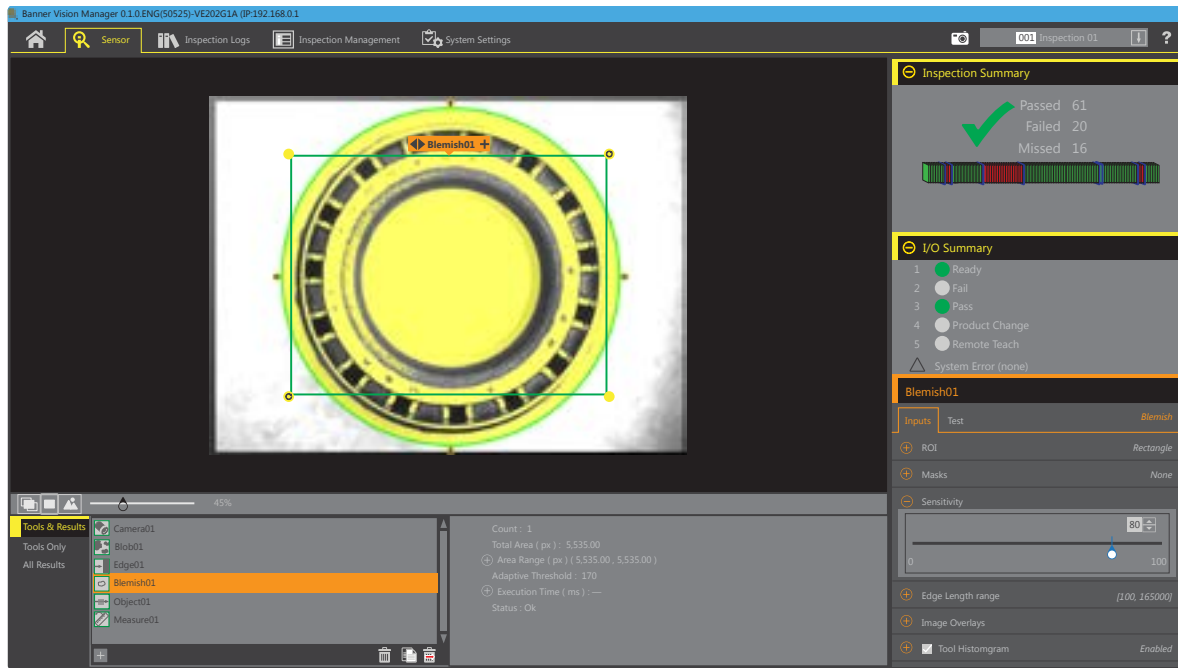

### Make Machine Vision and Barcode Reading More Intuitive

Vision Manager software takes the complexity out of vision and barcode reading applications. It features a graphical user interface and menu-driven tools that guide users through inspection setup and device management. Users of any experience level can easily navigate the intuitive operating environment and get their system up and running within minutes.

### Build Better Inspections with No Downtime

Create new inspections, troubleshoot existing inspections, or explore the capabilities of your system offline using the Vision Manager software emulator. Use runtime editing to update inspections while they are in progress without costly downtime from stopping and restarting inspections.

### Solve More Applications

This robust software platform provides a full set of powerful tools to solve thousands of applications, from simple feature verification and barcode reading to complex inspections on multiple objects or those requiring feature measurement, flaw analysis, or other advanced capabilities.



Compatible with both the iVu and VE

Start using today by downloading at [www.bannerengineering.com/vision-manager](http://www.bannerengineering.com/vision-manager).



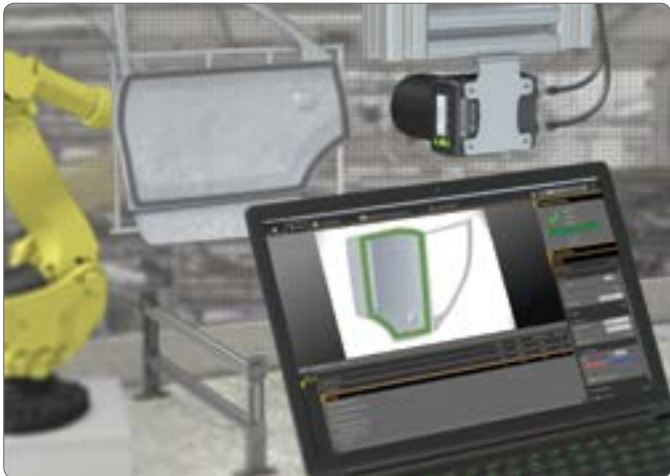

Door panel adhesive inspection using Bead Tool

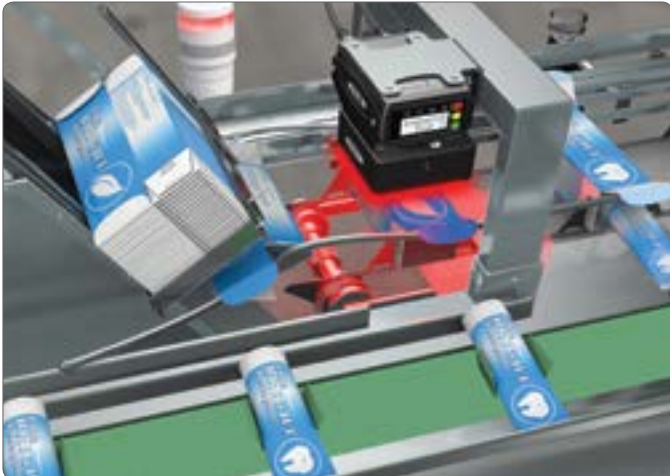

Correct carton inspection using Match Tool



Blister pack inspection using BLOB Tool



Cell phone inspection using Measure and Match Tools



Empty sortation conveyor inspection using Blemish Tool









# Barcode Readers

Banner Engineering provides advanced barcode reading capabilities for traceability in a wide variety of industries. We offer rugged, reliable solutions that ensure quality, improve efficiency, and enable accurate inventory management.

# Selection Guide | Barcode Readers

Advanced barcode reading capabilities for advanced traceability in a compact, rugged package. Banner's barcode readers also feature Ethernet communications.

Series	Reader Type	Configuration Options	Max. Reading Range*	Focus Type	Communication	Dimensions H x W x D (mm)	Page # or Web
 ABR 3000	Imager-based (1D, 2D)	Push Button PC	285 mm	Manual Focus	EtherNet/IP™ Modbus/TCP RS-232 RS-422 USB	Ethernet 45 x 24 x 49 USB 45 x 24 x 31	30
 ABR 7000	Imager-based (1D, 2D)	Push Button PC	800 mm	Manual focus Autofocus	EtherNet/IP™ Modbus/TCP RS-232 RS-422	75 x 54 x 43	30
 iVu BCR	Imager-based (1D, 2D)	Touchscreen PC	Lens Specific	Manual Focus	EtherNet/IP™ Modbus/TCP PROFINET® PCCC RS-232	95 x 81 x 52	70
 TCNM	Laser Scanner (1D)	Push Button PC	600 mm**	NA	RS-232	68 x 83 x 33	

\* For 20 mil 2D Code  
\*\* For 20 mil 1D code



Barcode reading for food traceability



Direct Part Mark (DPM) code reading and verification on automotive part



Barcode detection on semiconductor wafer



Read barcode on shipping label



## ABR Barcode Imager-Based Barcode Readers

ABR series barcode readers offer superior decoding capability and are available in two compact form factors, multiple resolutions, and a wide range of lens options.

- Powerful decoding capability to read even difficult 1D and 2D codes, including Direct Part Mark (DPM) and low contrast codes
- Compact metal housing for industrial environments
- Quick configuration with on-board push buttons or a PC using Barcode Manager, Banner's free operating software featuring an intuitive operating environment and advanced capabilities to solve the most difficult barcode reading applications
- Versatile lens options are available to simplify setup and configuration, including a software adjustable autofocus (ABR 7000) which easily adapts to changes in read distance
- Factory communication options include Ethernet/IP™, Modbus/TCP, Serial or USB for integration on the manufacturing floor
- Embedded webserver interface for monitoring images and statistics over any network



## Barcode Manager Software

Connect, configure, and monitor multiple ABR series barcode readers using Barcode Manager. This powerful software features intuitive, flowchart programming that makes it easy to setup inspections and access advanced features to solve the most difficult barcode reading applications.

### Quick and Easy Inspection Setup and Management

A wide range of configuration options, including a one-step process for automatic setup and an advanced option that provides full access to change and configure device settings.

### Remote Monitoring and Management

The web interface makes it possible to setup, manage, and monitor multiple barcode readers from any network-enabled location, providing users with tremendous flexibility in managing devices

### Identify Problems Early On

Code grading allows barcode readers to evaluate the quality of each barcode, making it easy to identify and resolve code issues early.

### Extend the Inspection Area

With multihead networking users can connect multiple barcode readers together in a network to solve complex applications over a very large inspection area.

## Capable of reading the following codes

1-D and Stacked		2D	Postal
<ul style="list-style-type: none"> <li>• PDF417 (Standard and Micro)</li> <li>• Code 128 (GS1-128)</li> <li>• Code 39 (Standard and Full ASCII)</li> <li>• Code 32</li> <li>• MSI</li> <li>• Standard 2 of 5</li> <li>• Matrix 2 of 5</li> </ul>	<ul style="list-style-type: none"> <li>• Interleaved 2 of 5</li> <li>• Codabar</li> <li>• Code 93</li> <li>• Pharmacode</li> <li>• UPC (EAN-8/13, UPC-A/E)</li> <li>• GS1 DataBar Family</li> <li>• Composite Symbolologies</li> <li>• Plessey</li> </ul>	<ul style="list-style-type: none"> <li>• Data Matrix ECC200 (Standard, GS1 and DPM)</li> <li>• QR Code (Standard and DPM)</li> <li>• Micro QR Code</li> <li>• MAXICODE</li> <li>• Aztec Code</li> <li>• Dotcode</li> </ul>	<ul style="list-style-type: none"> <li>• Australia Post</li> <li>• Royal Mail 4 State Customer</li> <li>• Kix Code</li> <li>• Japan Post</li> <li>• PLANET</li> <li>• POSTNET</li> <li>• POSTNET (+BB)</li> <li>• Intelligent Mail</li> <li>• Swedish Post</li> </ul>

## ABR 3000

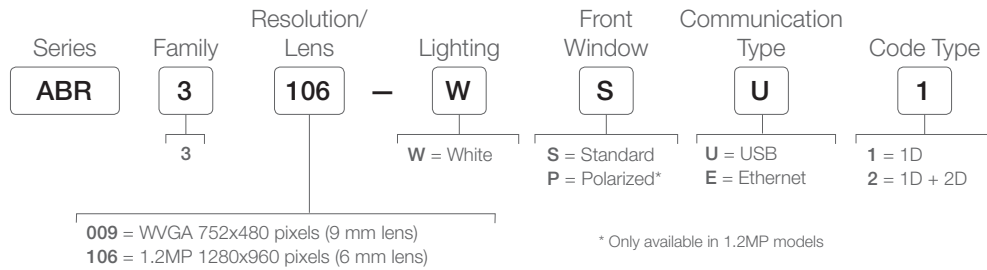
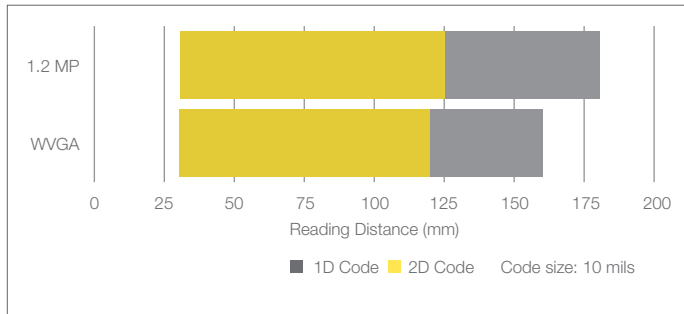

## ABR 7000

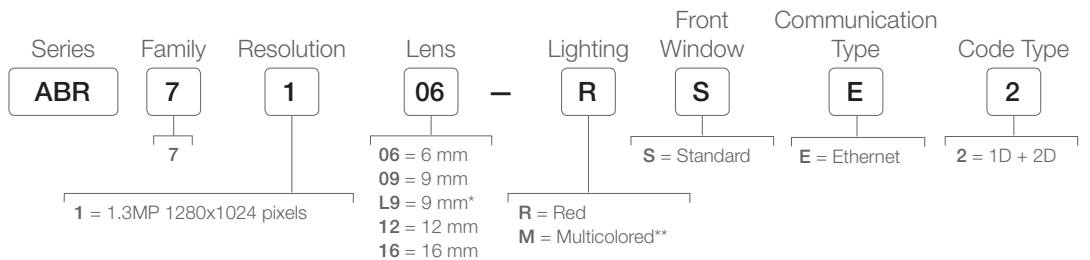
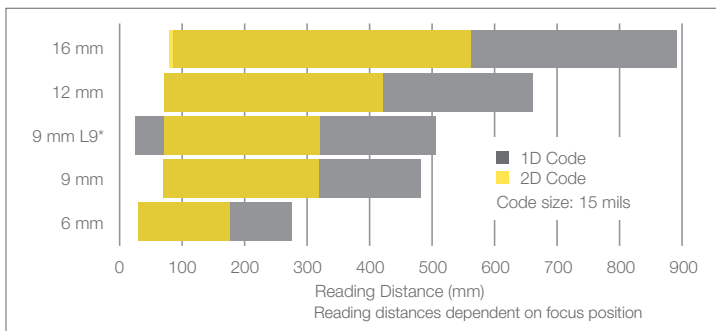

\* Liquid lens autofocus

\*\* Red and blue LEDs for optimized reading of DPM codes, available on 6 mm and 9 mm models only



## iVu Barcode Reader Powerful 1D and 2D Barcode Reader

- Program through integrated touchscreen, remote touchscreen or PC interface
- Reads a variety of 1D and 2D barcodes
- Ethernet (EtherNet/IP™, Modbus/TCP and PROFINET®) and Serial RS-232 communications
- Read multiple barcodes in any orientation with one device
- Rugged IP67 housing for factory environments
- Available with a variety of lens and integrated light options – red, blue, green, white, UV or infrared

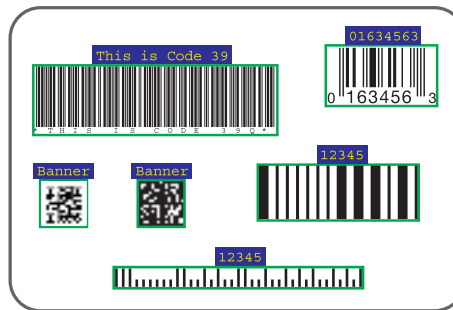

### 2D Barcodes

- Data Matrix ECC200
- QR code
- Micro QR code

### 1D Barcodes

- Code 128
- Code 39
- Codabar
- Interleaved 2 of 5
- UPC-E (EAN-8/13, UPC-A/E)
- EAN-8
- IMB
- Postnet
- Pharmacode

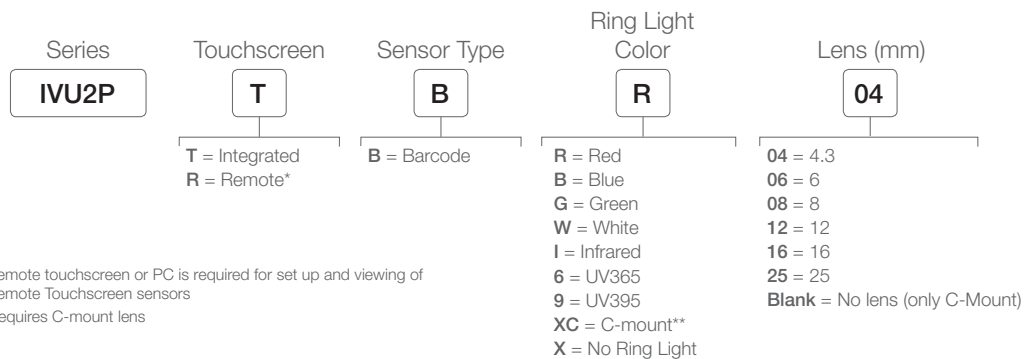



# Barcode Readers

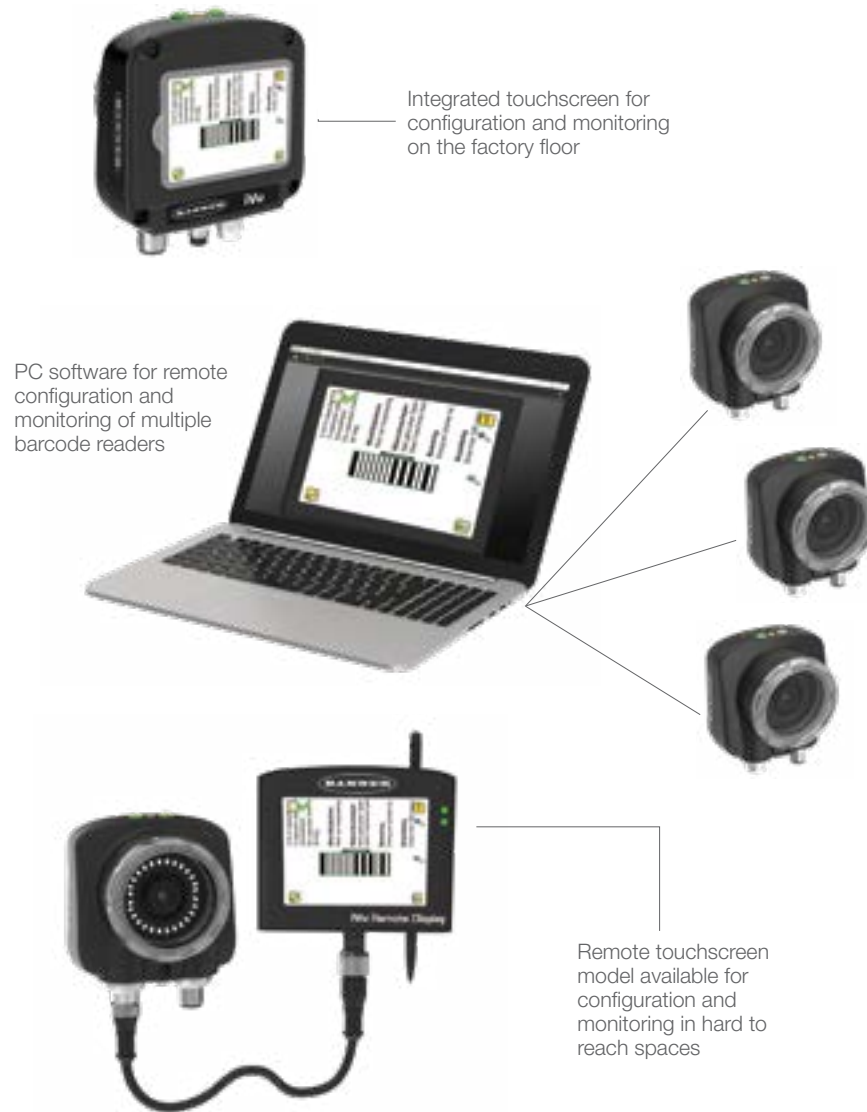

Read barcode on shipping label



Label verification on labeler machine





# Lighting & Indication

Banner's expansive selection of LED light fixtures, tower lights, indicators, and actuators shine brilliant and bright to provide superior-quality illumination, clear status indication, and unmistakable operator guidance and offer the low-power, long-life, maintenance-free advantages offered by LED technology.

# Lighting & Indication



Pro products give users flexibility to customize their machine's communication and streamline their supply chain. Full capabilities and dynamic response are available through IO-Link. The Pro Editor software allows fast customization of discrete controlled products. Programming hardware is compatible with all devices, and the software is free.

## Key Benefits

**Give your machines a voice:** More color and animation options allow for more intuitive indication in the visual factory. Show material level, process time, warmup status and more.

**Gain control of your supply chain:** Programmable RGB indicators make supply chains more efficient by allowing you to standardize on one model of indicator that can be customized as needed.

**Customize indication without additional lead time:** Choose from a wide variety of colors and animations to match process requirements, and preview settings on the device before deployment.

**Configuration options:** Control the animation state, color, intensity, speed, pattern, animation direction, and audible options, plus logic and wiring.



## EZ-STATUS®

- Multiply the value of your device – adding indication to illumination unlocks countless new applications.
- EZ-STATUS® multicolor lights give clear status information in addition to valuable machine illumination.

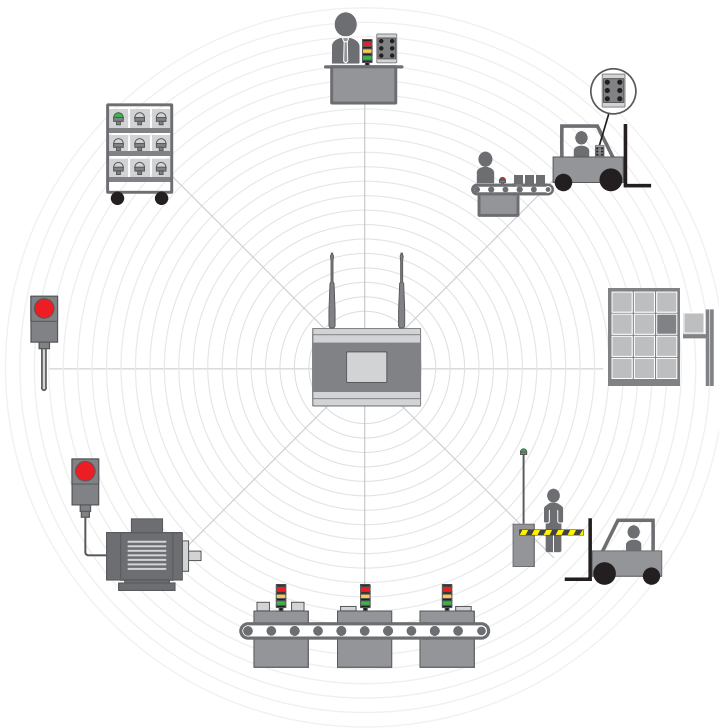
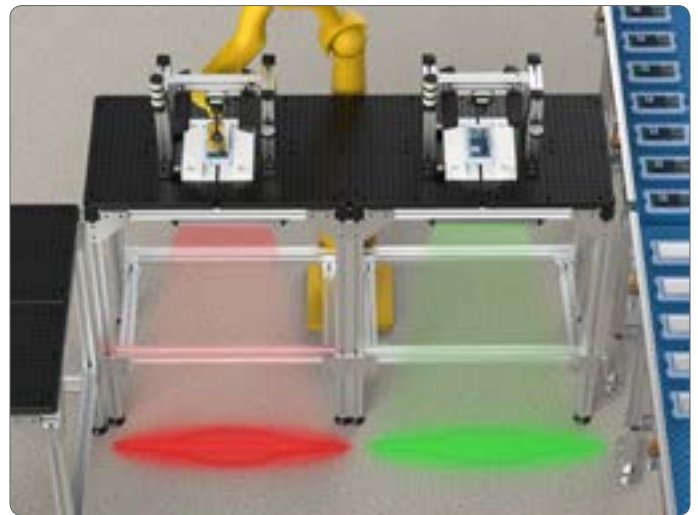

## Advanced Communication Options

IO-Link, wireless and serial communication options provide advanced configuration, remote control and monitoring capabilities, custom colors, dynamic indicator responses, and diagnostic information.

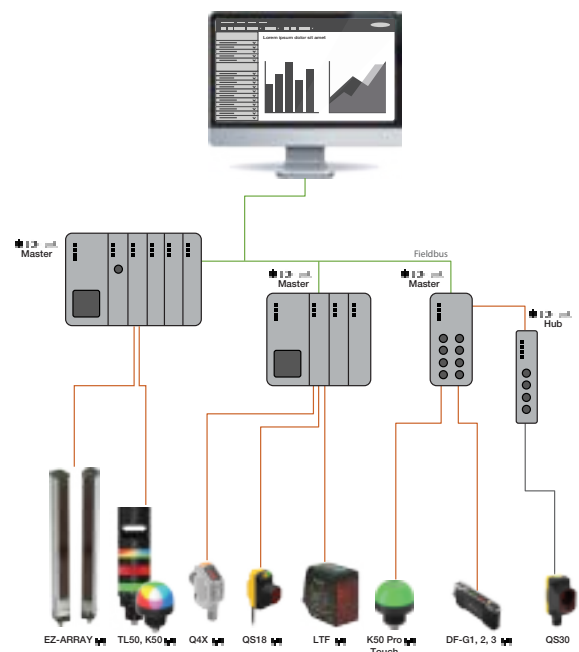

















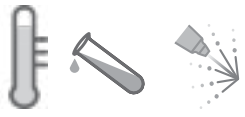







# Selection Guide | LED Task Lighting

Banner Engineering's industrial LED lighting products are high-quality and energy-efficient lights that provide bright illumination for 50,000 hours or more. Robust, vibration-resistant housings and sleek designs make Banner Engineering's LED lighting ideal for a wide range of industrial applications, including machine lighting, enclosure lighting, visual inspection illumination and work cell lighting.

Series	Length	AC/DC	White Lumens/Ft (300 mm)	Color Options	Environmental Rating	Special Considerations	Page # or Web
 WLS28-2	145 to 1130	DC	800		Unsealed IP50 Sealed IP67, IP69K	  EZ-STATUS®	
 WLS27	145 to 1130	DC	800		IP66 IP67 IP69K	   EZ-STATUS®  	
 HLS27	145 to 1130	DC	850		IP66 IP67		86
 WLS15	220 to 1200	DC	350		IP66 IP67	 EZ-STATUS®	
 WLB32	285 to 1130	AC DC	750		IP50		
 WLB92	550 and 1100	AC DC	1750		IP40		

**KEY**

-  Cascadable
-  Water Resistant
-  Hazardous Location
-  High Temp
-  Chemical Resistant





Series	Length	AC/DC	White Lumens/Ft (300 mm)	Color Options	Environmental Rating	Special Considerations	Page # or Web
 WLC60	340 and 640	DC	1300		IP68 IP68g IP69K		
 WLH60	340 and 640	DC	1150		IP68 IP69K		
 WLC90	89 x 91	DC	700		IP68 IP68g IP69K		
 WLA	105 x 180 to 360 x 180	DC	550		IP67 IP69K		
 WL50S	ø 50	DC	295		IP67 IP69K		
  WL50-2	ø 50	DC	225		IP67 IP69K		

# Selection Guide | Tower Lights

Preassembled and preconfigured multi-segment LED tower light indicators replace conventional stack lights, which often require time-consuming assembly and complex wiring. Various tower light models result in customized solutions, including a choice of ac or dc supply power, three audible output options, standard or high light intensities and quick-disconnect or pre-wired options.

Family	Diameter (mm)	AC/DC	Max Segments	Color Options	Environmental Rating	Special Considerations	Page # or Web
 TL70	70	AC DC	6		IP65		
 TL50	50	AC DC	10		IP67		
 TL50C	50	AC DC	10		IP67		
 TL50BL	50	AC DC	10		IP67		
 CL50	50	AC DC	1		IP67		
 TL30	30	DC	5		IP65		86

**KEY**

































-  Multicolor
-  Audible
-  Daylight Visible
-  Wireless
-  Modular Segments











# Selection Guide | LED Indicators

Banner Engineering's LED indicators offer a wide variety of bright, highly visible models ranging from daylight visible to multiple colors in one device. Indicators have a rugged design for long-term use and require no additional protective box.

Series	Dome Size (mm)	Mounting Hole Dia. (mm)	AC/DC	Color Options	Environmental Rating	Special Considerations	Page # or Web
 K30 Pro K50 Pro K50C Pro	30 50 50	22 30 30	DC	7, 14 colors more with IO-Link	IP66 IP67 IP69		
 K30L K50L	30 50	22 30	AC DC	K30: 1-3 colors K50: 1-5 colors	IP67 IP69K		
 K50FL	50	Flat Mount	DC	1-5 colors	IP67 IP69K		
 K50BL	50	30	AC DC	1-3 depending on model	IP67 IP69		
 K70L	70	30	DC	1-5 colors	IP65		
 K90L	90	30	DC	1-5 colors	IP67		
 K80FL	66	Flat Mount	DC	1-9 colors	IP67		
 K80	50	Flat Mount	AC DC	1-5 colors	IP67		
 SP Series	50	Flat Mount	AC DC	1-3 colors	IP67		
 S22 Pro	20	22	DC	1-14 colors	IP65 IP67 IP69K		87
 S18L S22L	18	18 22	DC	1-3 colors	IP67 IP69K		





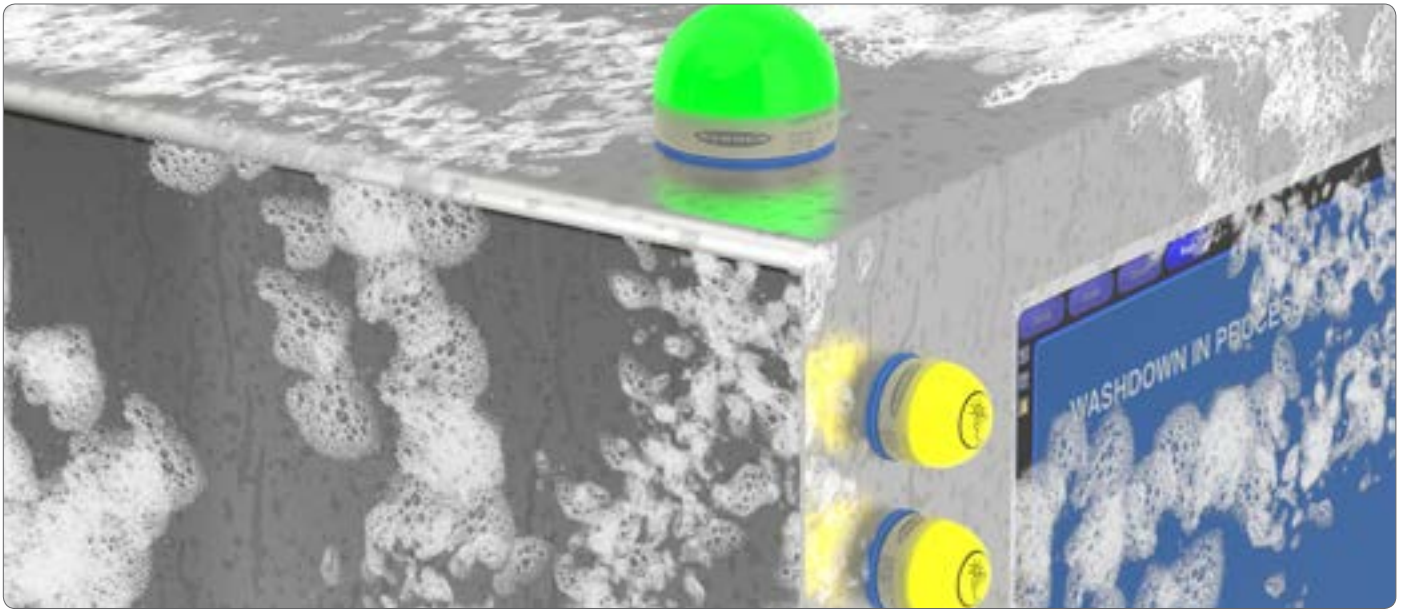

























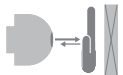

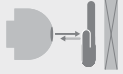





**KEY**

-  Multicolor
-  Audible
-  Daylight Visible
-  Flash
-  Wireless
-  Hazardous Location



# Selection Guide | Touch Buttons

Banner is the leader in ergonomic, visual and sealed operator touch buttons for industrial applications. Since Banner touch buttons can have multiple colors and I/O capabilities, they can replace several conventional buttons, making them ideal in lean manufacturing environments.

Series	Size (mm)	Mounting Hole (mm)	Actuation Method	Color Options	Environmental Rating	Special Considerations	Page # or Web
 S22 Pro	20	22		7, 14	IP66 IP67 IP69K		87
 K30	30	22			IP67 IP69K		
 K50 K50 Pro	50	30		Pro: 7, 14 IO-Link: More	IP67 IP69K		87
 K70	70	30			IP65		
 K30L/K50L Push Button	30 50	22 30			IP65		
 OTB	74.2 x 59.9 x 43.2	30		NA	IP65		
 VTB	73.3 x 43.2 x 43.2	30			IP65		
 Flush-Mount Illuminated E-Stops	102.1 x 80.8 x 80.3	NA			IP65		
 Illuminated E-Stops	119.8 x ø 80	30			IP65 IP69 with cover		
 OS80	119.8 x ø 80	30			IP40 IP69 with cover		





























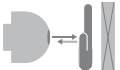



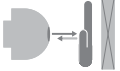

**KEY**

-  Cascadable
-  Multicolor
-  Audible
-  Daylight Visible
-  Wireless

# Pick-To-Light

Pick-to-light sensors help industrial automation manufacturers reduce the risk of error in the assembly process, boosting product quality and reducing cost.

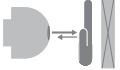

Series	Size (mm)	Mounting Hole (mm)	Actuation Method	Color Options	Environmental Rating	Special Considerations	Page # or Web
 PTL	35 x 110 x 30	NA	 and/or	14	IP54		84
 S22 Pro	20	22		7, 14	IP66 IP67 IP69K		87
 K30	30	22			IP67 IP69K		
 K50 K50 Pro	50	30		7, 14	IP67 IP69K		87
 K70	70	30			IP65		
 K50 Optical	50	30			IP67 IP69K		
 K30/K50/K80 Push Button	30 50 80	22 30 NA			IP65		
 PVD	Sensing Length 100 or 225	NA		NA	IP62		
 PVA	Sensing Length 100 225 300 375	NA		NA	IP62		
 PVL	Sensing Length 225 or 500	NA		NA	IP50		

## PTL110 Scalable, Versatile Pick-to-Light Solution

- Achieve fast picking speeds in large scale systems with PICK-IQ™ serial communication
- Optimize application performance with options including optical sensor, touch button and display
- Reduce system costs with simple mounting and direct device connection



Built-in holes for easy mounting using zip ties



Mounting options are available for fast installation and part moves

Three-digit display to show pick count and more



Touch button provides a reliable manual interface



Built-in optical sensor for direct pick detection



Define primary and secondary sensor functions to expand capabilities of a single device

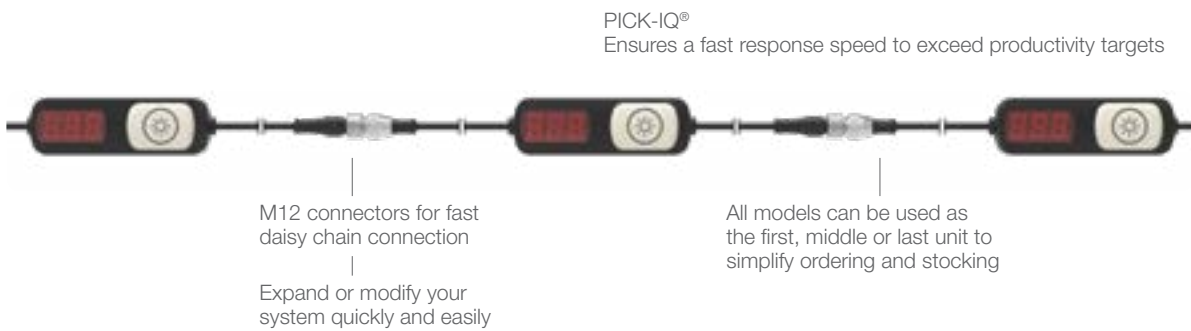
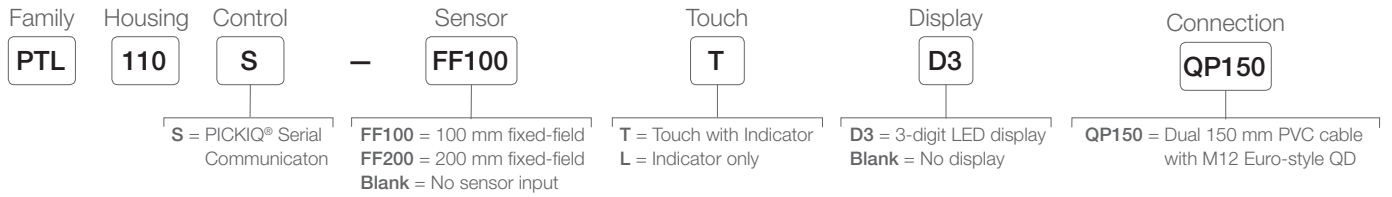

## Monitor and Control

PTL devices are controlled by Modbus master



Customizable indication with up to 14 colors gives maximal visual clarity



### DXM700 Controller

- Use as master device for protocol conversion and system initialization
- Collect pick metrics for analysis and system optimization
- Choose an embedded radio model for wireless installations

# Lighting & Indication

## TL30 Basic 30 mm Tower Light

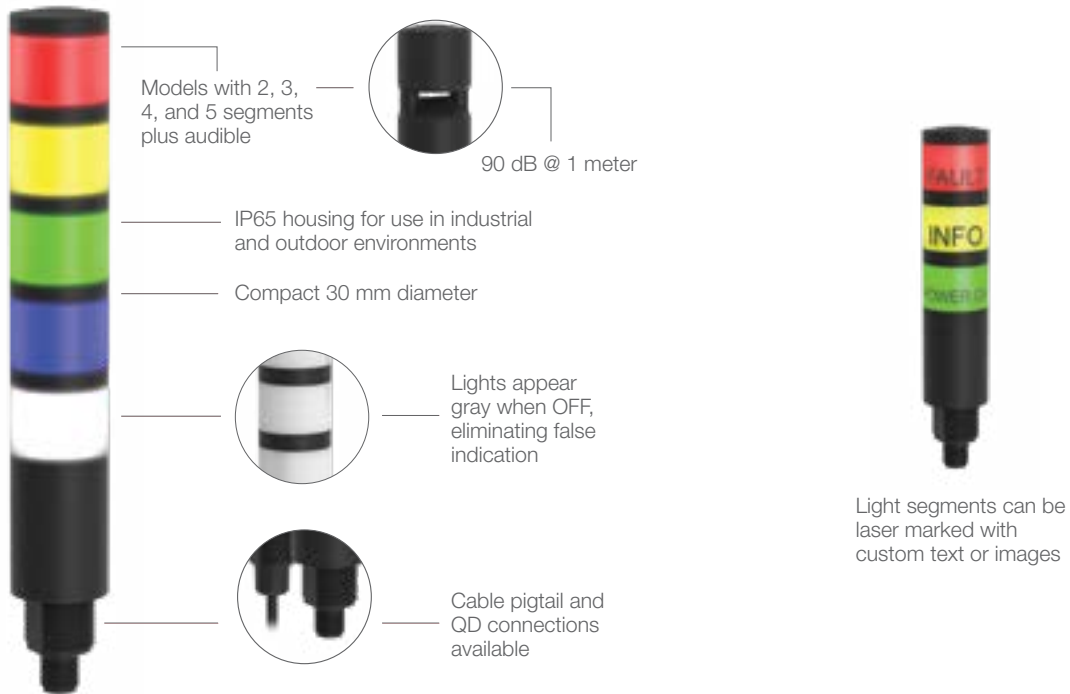

## HLS27 Hazardous Location LED Strip Lights



- Certified for use in Class I Division 2, Class II Division 2, Class III Division 1 & 2, and Zone 2 & 22 locations
- Single- and dual-color models for advanced signaling, inspection and other applications
- Custom brackets make mounting easy and protect against impact
- Intensity control via Hi/Lo/Off wiring or PWM dimming

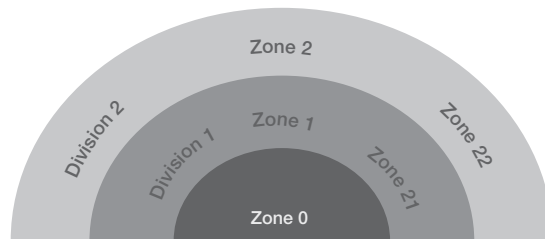

Models with 2.0 (6.3 ft) ITC-ER cable and unterminated tinned leads:

NEC and CEC:

Gas & Vapors: Class I Zone 2 IIC T4 / Class I Div 2 Groups ABCD T4

Dust: Class II Zone 22 IIIC T100°C / Class II Div 2 Groups FG T5

Fibers: Class III Div 1 and Div 2 T5

ATEX/IECEX:

Gas & Vapors: II 3 G Ex ec IIC T4 Gc (Group IIC Zone 2)

Dust: II 3 D Ex tc IIIC T85°C Dc (Group IIIC Zone 22)





## K50 Pro Touch Buttons

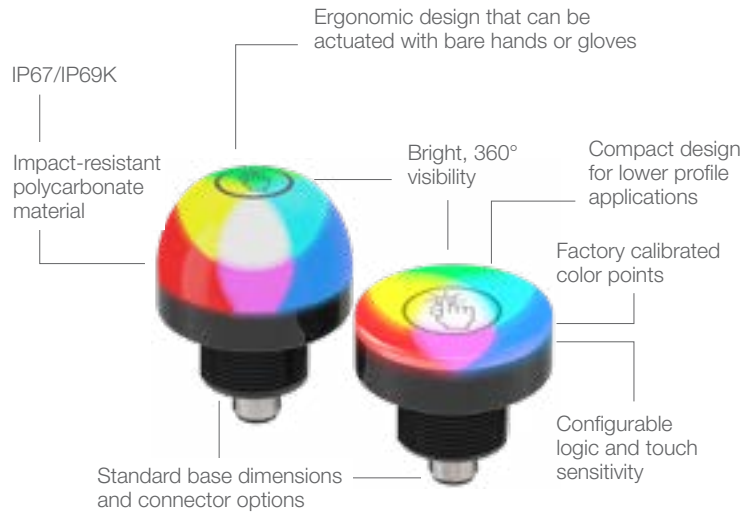

## S22 Pro Touch Buttons and Pro Indicators



- Large, bright illuminated area for clear visibility
- IP69K design for washdown environments
- Flush mount design sits tight against surfaces
- Terminal and cable options for fast, economical installation
- Bimodal inputs (PNP/NPN) for part count reduction
- FDA-grade models available
- Pro Editor software compatible

## WLS27 LED Strip Lights

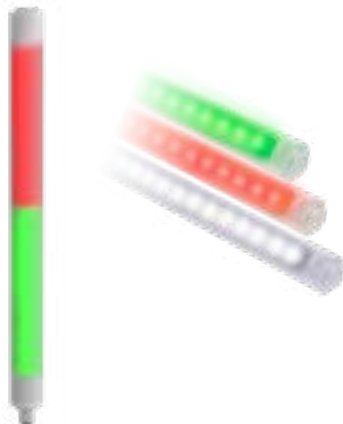

- The popular IP69-rated, chemically-resistant housing adds new electronics
- Pro models enhance illumination, status indication and process feedback applications
- Controlled by IO-Link or configured via Pro Editor software for discrete control
- Segmented core models replace tower lights and stop lights, or add multiple indication states to machinery
- EZ-STATUS® models provide discrete control of three or five colors, perfect for adding indication to illumination



Avoid nuisance maintenance and replacement expense



Select compliant models for use in food and beverage processing



Adjustable touch sensitivity



Excellent immunity to false triggering in washdown environments



Simplify ordering, stock and spare parts with flexible, customizable units



Customize device configuration with advanced animation options and touch settings. Visit [www.bannerengineering.com/proeditor](http://www.bannerengineering.com/proeditor) for full details on the Pro Editor software



















# Connectivity & Monitoring

Wireless products from Banner connect remote assets with the people who manage them, enabling real-time monitoring and management of equipment and conditions in difficult-to-access locations or where wired solutions are impractical, ineffective or cost-prohibitive.



# Selection Guide | Industrial Wireless Radios

Easily replace discrete, analog, serial, and ethernet signal wires. With no setup software needed, data radios are easy to apply, use, and support. With wireless I/O, you can create expandable point-to-multi-point wireless networks that distribute I/O over large areas

Series	Description	Page # or Web
 <p>PM Series – Wire Replacement</p>	An I/O radio network that combines long range line-of-sight coverage with ease of deployment and use. The PM2 Series has four sourcing discrete inputs, four sourcing discrete outputs, two analog inputs and two analog outputs in both the Gateway and the Node.	
 <p>Performance Series Gateways and Nodes</p>	Create point-to-multi point networks that distribute I/O over large areas. Input and output types include discrete (dry contact, PNP/NPN), analog (0 to 10 V dc, 0 to 20 mA), temperature (thermocouple and RTD), and pulse counter.	
 <p>Performance Series Basic Nodes</p>	The Performance Series P6L Node is low-cost, battery-powered device that can convert Banner 1-wire serial sensor device into a wireless input. All configuration is done through internal DIP switches or the DX80 User Configuration Tool.	
 <p>MultiHop Modbus I/O Data Radios</p>	MultiHop Modbus Data Radios extend the range of Modbus or other serial communication networks. Each radio may be set to act as either a master, repeater or slave. Models are available with built in discrete and analog I/O, which can be accessed using the Modbus protocol.	
 <p>Ethernet Data Radios</p>	Sure Cross® MultiHop Ethernet Data Radios are wireless industrial communication devices used to create point to multipoint configurations of wireless Ethernet networks.	
 <p>Serial Data Radios</p>	Sure Cross® MultiHop Serial Data Radios are wireless industrial communication devices used to extend the range of serial communication networks.	
 <p>Hazardous Area Radios – Metal Housing</p>	Hazardous area radios are a state-of-the-art combination of wireless communication, battery technology and intrinsically safe electronics. Networks are formed using DX80 Performance Gateways installed beyond the hazardous area and one or more Nodes operating in the same frequency band.	





## Wireless Controllers

Industrial wireless controllers that facilitate Ethernet connectivity and Industrial Internet of Things (IIoT) applications.



Series	Description	Page # or Web
 <p>Industrial Wireless Controller: DXM Series</p>	The DXM controller series integrates Banner's wireless radio, cellular and Ethernet connectivity, and local I/O to provide a platform for the Industrial Internet of Things (IIoT).	97
 <p>Wireless Solutions Kit</p>	Wireless Solutions Kits make it easy to monitor remote and mobile assets, collect and act on data, and solve specific applications. No programming is required. Simply plug in the box, bind the nodes, install the sensors and nodes, and begin collecting data.	96

# Wireless Sensors









Wireless sensors, lighting, and indicators allow you to remotely monitor and diagnose systems quickly, which reduces downtime, increases productivity, and provides data to optimize your operation. They are easy to install and setup, eliminate expensive cable runs, and can integrate machines that were not previously network capable.

Series	Description	Special Consideration	Page # or Web
 <p>QM42 Vibration &amp; Temperature Series</p>	The QM42VT Vibration and Temperature Sensor makes it easy to monitor a machine's health. It measures multiple vibration characteristics and temperature so that problems can be detected before they become too severe and cause additional damage or result in unplanned downtime. Paired with a Banner wireless Node, it can provide local indication, wirelessly send the signal to a central location, and send the vibration and temperature data to the Gateway for collection and trending.		
 <p>Temperature &amp; Humidity Sensor Series</p>	Sure Cross® Temperature and Humidity Sensors work in a variety of environments to provide temperature and humidity measurements. Used with Sure Cross Wireless Radios, these sensors make it easy to monitor environmental conditions without costly wiring runs to monitoring points.		
 <p>Wireless Ultrasonic Sensors – K50U Series</p>	The K50U ultrasonic sensor makes it easy to monitor mobile and remotely located tanks and totes		
 <p>Q45 Nodes for Predictive Maintenance</p>	Sure Cross® Q45 1-Wire Serial Nodes are designed to work with Banner's 1-Wire Serial Sensors. Their compact size, integrated lithium batteries, and variety of compatible sensors make remote monitoring easy.		95
 <p>Q45 Switches and Push Buttons</p>	Sure Cross® Q45 Switches and Push Buttons are designed to accept remote dry contact, NAMUR, and discrete non-contact switch inputs for use in many factory automation, remote monitoring, and IIoT applications.		94
 <p>Q45 Photoelectric Wireless Sensors</p>	Sure Cross® Q45 Photoelectric Sensors combine a sensor, wireless node, and an internal battery in a single device, making it easy to solve challenging factory applications or add sensing to existing industrial systems.		94
 <p>Wireless M-GAGE Node</p>	<i>FlexPower</i> Node with internal battery designed for vehicle detection.		
 <p>Wireless Ultrasonic Sensor Node</p>	Wireless <i>FlexPower</i> Node with internal battery designed for object or vehicle detection		
 <p>GPS Receiver</p>	Low power consumption, ability to withstand harsh environments, flexible power supply requirements and Modbus RTU communications makes this module ideal for the industrial market.		
 <p>Wireless Q120 Pendants</p>	An autonomous wireless Node that enables two-way communication between an operator and up to six remote and/or mobile devices.		

**KEY**

 Vibration
  Temp
  Ultrasonic

# Selection Guide | Wireless Lighting and Indicators

Series	Description	Page # or Web
 TL70 Tower Lights	Wireless TL70 Modular Tower Light is bigger, brighter and can be ordered as modular segments or pre-assembled. TL70 Tower Lights combine Banner's popular Tower Light family with its reliable, field proven, Sure Cross wireless architecture.	
 TL70 Wireless Segment	The TL70 wireless communication segment makes it easy to add network connectivity to any TL70 Tower Light with a standard base.	
 70 mm Wireless Touch Buttons – K70 Series	The EZ-LIGHT K70 touch button is a large, easy to activate solid state switch and high visibility indicator. Touch buttons in this series are ideal for use in pick-to-light, call button and general industrial applications.	
 70 mm Wireless Domed Indicators – K70 Series	Wireless K70 Indicators are bright, multicolored indicators with a 70 mm dome and offer increased communication possibilities and greater versatility in deployment.	

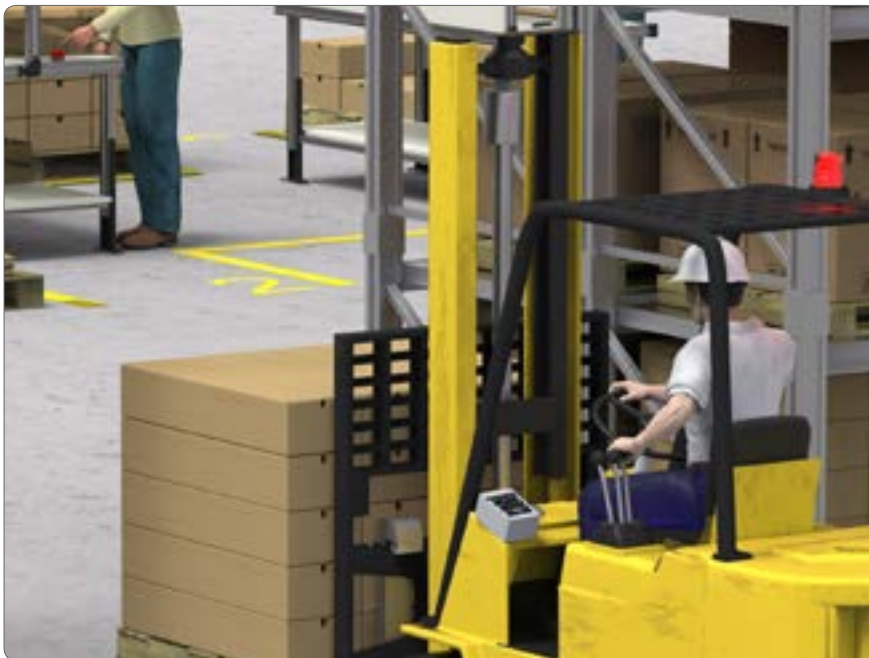

# Q120PPB Pendant

## Interface Device

The Wireless Q120PPB Pendant station is a compact, industrial, battery-powered operator interface device that can be used to wirelessly transmit two discrete inputs to a wireless controller/gateway. These inputs provide for remote control and local LED indication. All configuration is done through internal DIP switches or through the Banner DX80 Configuration Tool.

- Powerful operator interface device to deliver factory automation and IIoT solutions for many applications including but not limited to:
  - Call for parts, service, or pallet pickup
  - Remote door control
  - AGV control
  - Motor jog control
  - Perimeter gate control, etc.
- Easy-to-use rugged device that can be handheld or mounted to equipment
- Two independent normally open operators for monitoring or control
- Local LED indication can be linked to operator status or to other wireless inputs within the network
- Battery powered for “peel and stick” functionality with a two-year battery life capability
- Eliminate control wires—The Sure Cross wireless system is a radio frequency network with integrated I/O that removes the need for power and control wires
- Reduce complexity—Machine or process reconfiguration made easier; great for retrofit applications
- Deploy easily—Simplify installation on existing equipment enables deployment in remote and hard-to-access locations where implementing a wired solution would be difficult, impractical, or not cost-effective

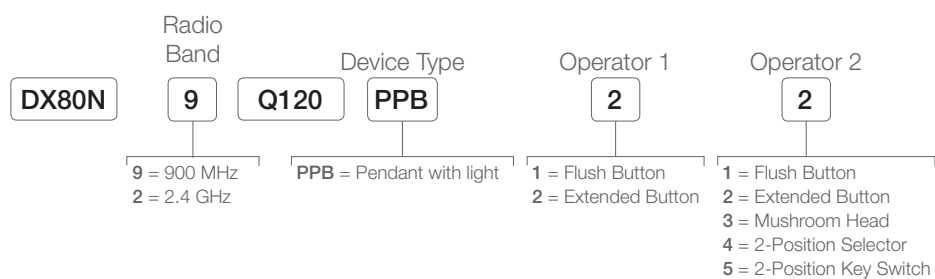



## Q45 Photoelectric Sensors

Q45 Photoelectric Sensors combine a sensor, wireless node, and an internal battery to make it easy to solve challenging factory applications or add sensing to existing industrial systems.

- Truly self-contained with no need for cables, cord sets, or external power
- Up to 1.5 years of battery life
- Designed for fast installation and ease of changeovers

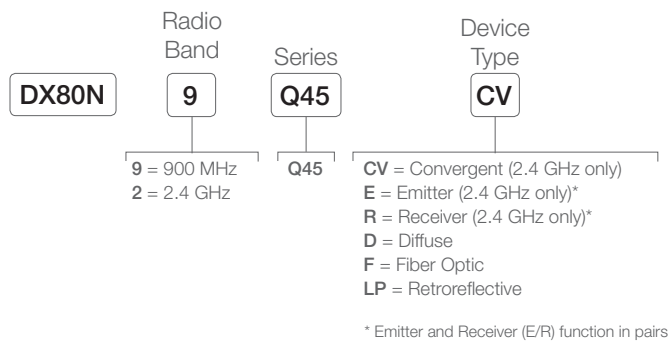

## Q45 Switches and Push Buttons

Sure Cross® Q45 Switches and Push Buttons are designed to accept remote dry contact, NAMUR, and discrete non-contact switch inputs for use in many factory automation, remote monitoring, and IIoT applications.

- Remote discrete models are designed to interface with isolated dry contact inputs or NAMUR inductive proximity sensors.
- Button and light models have independently controlled push button inputs and a multi-color LED indicator light.
- Remote discrete non-contact switch models use a reed switch and a magnet to sense the position of mechanical devices such as doors, levers, valves, and other actuators.

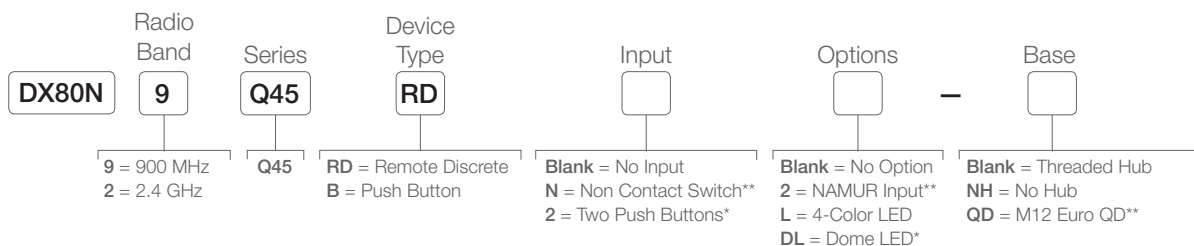

\* Only available with B model  
 \*\* Only available with RD model



# Q45 Nodes for Predictive Maintenance

To save on installation time, Q45 1-wire serial nodes are pre-configured to work with Banner 1-wire serial sensors. The compact size, integrated lithium batteries, and a variety of compatible sensors make remote monitoring easy.

- The Q45VTP is designed to pair with the QM42VT1 vibration and temperature sensor. Vibration characteristics and sample intervals can be set using DIP switches.
- The Q45TH connects directly to the M12FTH4Q temperature and humidity sensor. Sample rates can be set using DIP switches.
- The Q45U is a universal 1-wire serial node that reads any Banner 1-wire serial sensor and determines an efficient power setting.



### Select Your Node

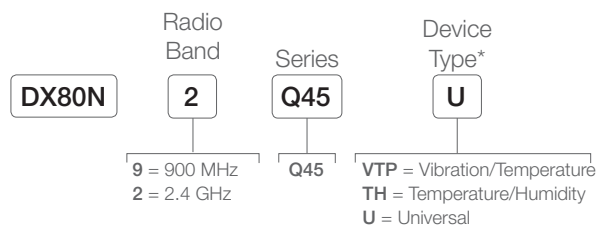

\* Sensor units must be ordered separately

### Select Your Sensor



# Q45 All-in-One Sensor

- Vibration or Tank Level sensor and node in one compact package
- Uses a 1-wire serial interface
- Easy-to-order
- Easy-to-deploy
- DIP switch configurable for vibration characteristics and sample intervals
- Dual-axis vibration sensing



### Vibration: Sensor and Node

Models	Description
DX80N9Q45VA	All-in-one Vibration sensor – 900 MHz
DX80N2Q45VA	All-in-one Vibration sensor – 2.4 GHz

### Ultrasonic: Sensor and Node

Models	Range	Description
DX80N9Q45UAC	900 MHz	Q45 Node with Integrated Ultrasonic Sensor
DX80N2Q45UAC	2.4 GHz	Q45 Node with Integrated Ultrasonic Sensor

# Wireless Solutions Kit Tank Level or Vibration

Wireless Solutions Kits are fully integrated and easy-to-use solutions for monitoring assets and solving specific applications. They are designed to make it easy for users of any experience level to setup a wireless network, collect remote data, and create visualization tools, warnings, and alarms.

- No programming is required. Plug in the box, bind the nodes through the HMI screen, install the sensors and nodes, and start collecting data
- Includes pre-programmed DXM100 wireless controller, pre-programmed 10.1 inch touchscreen HMI, and 5-port industrial Ethernet switch
- HMI provides graphical displays of collected data, baselines, thresholds, warnings, and alarms
- Access raw data right on the HMI or via the cloud from any network accessible location
- View up to 7 days of data history on HMI screen and archive over 30 days of logged data in CSV files
- Increase productivity by using warnings and alarms to quickly identify and resolve potential issues

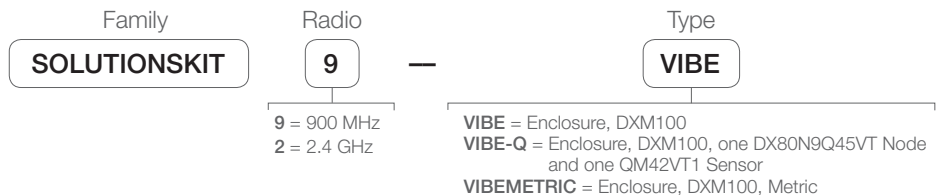
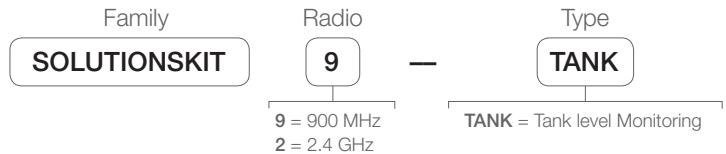
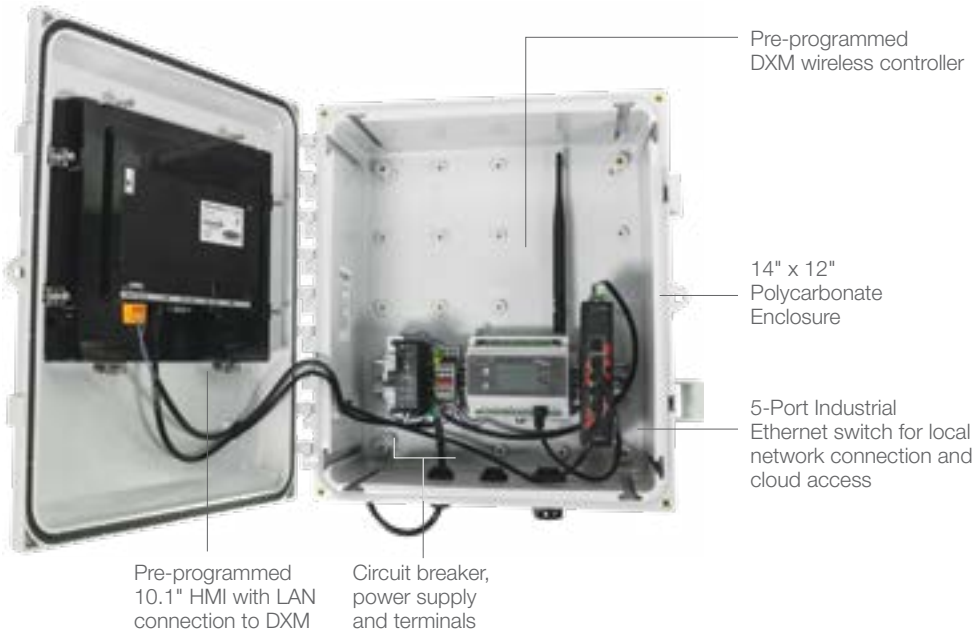

# DXM Controller

DXM Series industrial wireless controllers are designed to facilitate Ethernet connectivity and Industrial Internet of Things (IIoT) applications. Available with an internal DX80 Gateway or a MultiHop Data Radio, these powerful Modbus communications devices connect local wireless networks with the internet and/or host systems.

- ISM radios available in 900 MHz and 2.4 GHz for local wireless network
- Converts Modbus RTU to Modbus TCP/IP or Ethernet I/P
- Logic controller can be programmed using action rules and text language methods
- Micro SD card for data logging
- Email and text alerts
- Local I/O options
- Powered by 12 to 30 V dc, 12 V dc solar panel, or battery backup
- RS-232, RS-485, and Ethernet communications ports; and a USB configuration port
- LCD display for I/O information and user programmable LED's
- Cell modem for cellular connectivity

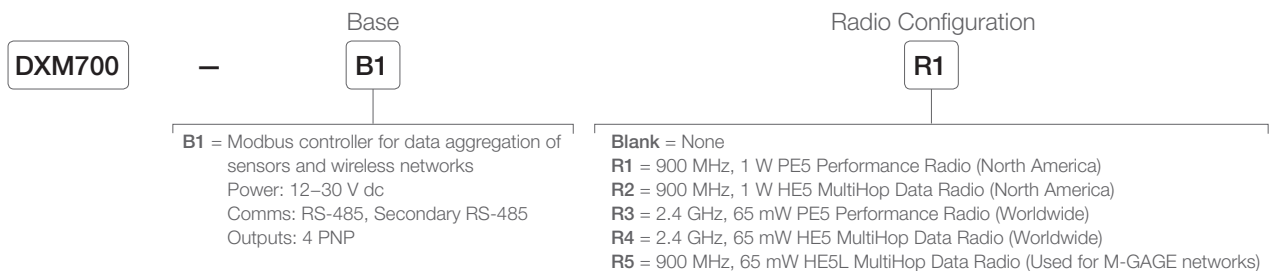



**Banner Engineering Corp.**

9714 Tenth Avenue North • Minneapolis, Minnesota 55441  
763-544-3164 • 1-888-373-6767

[www.bannerengineering.com](http://www.bannerengineering.com)

